

# TransAcoustic™

TA3

# SILENT *Piano*™

SH3 / SC3

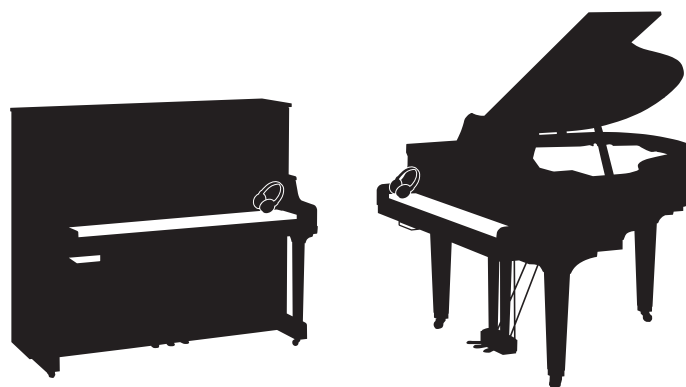

Owner's Manual  
Manual de instrucciones  
Mode d'emploi  
Benutzerhandbuch  
Manuale di istruzioni  
Руководство пользователя

Before using the instrument, be sure to read "PRECAUTIONS" on pages 6-7.

Antes de utilizar el instrumento, lea la sección "PRECAUCIONES", en las páginas 6-7.

Avant d'utiliser cet instrument, lisez attentivement la section « PRÉCAUTIONS D'USAGE » aux pages 6-7.

Achten Sie darauf, vor Einsatz dieses Instruments die „VORSICHTSMAßNAHMEN“ auf Seiten 6-7 durchzulesen.

Prima di utilizzare lo strumento, assicurarsi di leggere la sezione "PRECAUZIONI", alle pagine 6-7.

Перед началом работы с инструментом прочитайте раздел «ПРАВИЛА ТЕХНИКИ БЕЗОПАСНОСТИ» на стр. 6-7.

## FCC INFORMATION (U.S.A.)

### 1. IMPORTANT NOTICE: DO NOT MODIFY THIS UNIT!

This product, when installed as indicated in the instructions contained in this manual, meets FCC requirements. Modifications not expressly approved by Yamaha may void your authority, granted by the FCC, to use the product.

### 2. IMPORTANT:

When connecting this product to accessories and/or another product use only high quality shielded cables. Cable/s supplied with this product MUST be used. Follow all installation instructions. Failure to follow instructions could void your FCC authorization to use this product in the USA.

### 3. NOTE:

This product has been tested and found to comply with the requirements listed in FCC Regulations, Part 15 for Class "B" digital devices. Compliance with these requirements provides a reasonable level of assurance that your use of this product in a residential environment will not result in harmful interference with other electronic devices. This equipment generates/uses radio frequencies and, if not installed and used according to the instructions found in the users manual, may cause interference harmful to the operation of other electronic devices. Compliance with FCC regulations does not guarantee that interference will not occur in all installations. If this product is found to be the source of interference, which can be determined by turning the unit "OFF" and "ON", please try to eliminate the problem by using one of the following measures:

- Relocate either this product or the device that is being affected by the interference.
- Utilize power outlets that are on different branch (circuit breaker or fuse) circuits or install AC line filter/s.
- In the case of radio or TV interference, relocate/reorient the antenna. If the antenna lead-in is 300 ohm ribbon lead, change the lead-in to co-axial type cable.

If these corrective measures do not produce satisfactory results, please contact the local retailer authorized to distribute this type of product. If you cannot locate the appropriate retailer, please contact Yamaha Corporation of America, 6600 Orangethorpe Avenue, Buena Park, CA 90620, U.S.A.

The above statements apply ONLY to those products distributed by Yamaha Corporation of America or its subsidiaries.

(529-M04 FCC class B YCA 02)

### COMPLIANCE INFORMATION STATEMENT (Supplier's declaration of conformity procedure)

Responsible Party: Yamaha Corporation of America  
Address: 6600 Orangethorpe Avenue, Buena Park, CA. 90620, U.S.A.  
Telephone: 714-522-9011  
Type of Equipment: TransAcoustic™ Piano  
Model Name: U1TA3, U3TA3, YUS1TA3, YUS3TA3, YUS5TA3, C1XTA3,  
C3XTA3, GC1TA3

This device complies with Part 15 of the FCC Rules.

Operation is subject to two following conditions:

- 1) this device may not cause harmful interference, and
- 2) this device must accept any interference received including interference that may cause undesired operation.

(529-M02 FCC sdoc YCA 02)

### COMPLIANCE INFORMATION STATEMENT (Supplier's declaration of conformity procedure)

Responsible Party: Yamaha Corporation of America  
Address: 6600 Orangethorpe Avenue, Buena Park, CA. 90620, U.S.A.  
Telephone: 714-522-9011  
Type of Equipment: SILENT Piano™  
Model Name: U1SH3, U3SH3, YUS1SH3, YUS3SH3, YUS5SH3, C1XSH3,  
C2XSH3, C3XSH3, C5XSH3, C6XSH3, C7XSH3, GC1SH3,  
GC2SH3, S3XSH3, S5XSH3, S6XSH3, S7XSH3, B1SC3, B2SC3,  
B3SC3, P22DSC3, GB1KSC3

This device complies with Part 15 of the FCC Rules.

Operation is subject to two following conditions:

- 1) this device may not cause harmful interference, and
- 2) this device must accept any interference received including interference that may cause undesired operation.

(529-M02 FCC sdoc YCA 02)

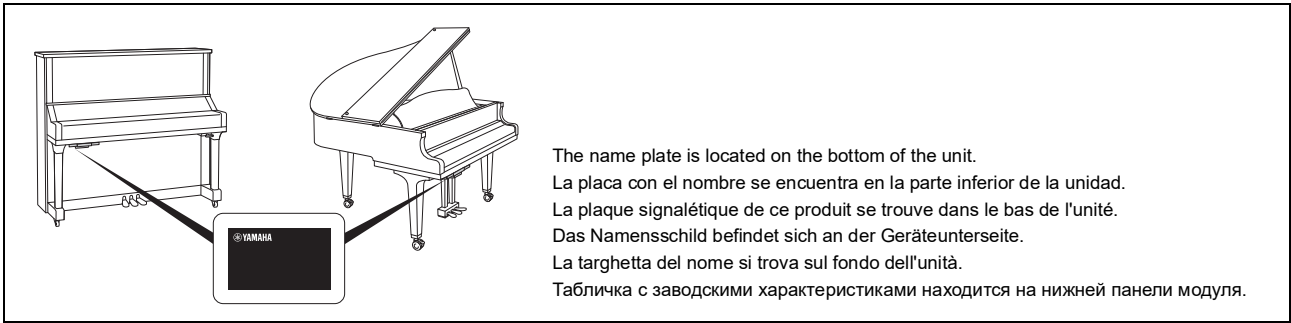

The model number, serial number, power requirements, etc., may be found on or near the name plate, which is at the bottom of the unit. You should note this serial number in the space provided below and retain this manual as a permanent record of your purchase to aid identification in the event of theft.

**Model No.**  
 \_\_\_\_\_

**Serial No.**  
 \_\_\_\_\_

(1003-M06 plate bottom en 01)

Die Nummer des Modells, die Seriennummer, der Leistungsbedarf usw. sind auf dem Typenschild, das sich auf der Unterseite des Geräts befindet, oder in der Nähe davon angegeben. Sie sollten diese Seriennummer an der unten vorgesehenen Stelle eintragen und dieses Handbuch als dauerhaften Beleg für Ihren Kauf aufbewahren, um im Fall eines Diebstahls die Identifikation zu erleichtern.

**Modell Nr.**  
 \_\_\_\_\_

**Seriennr.**  
 \_\_\_\_\_

(1003-M06 plate bottom de 01)

El número de modelo, el número de serie, los requisitos de alimentación, etc. pueden encontrarse en la placa de identificación o cerca de ella. Esta placa se encuentra en la parte inferior de la unidad. Debe anotar dicho número en el espacio proporcionado a continuación y conservar este manual como comprobante permanente de su compra para facilitar la identificación en caso de robo.

**Nº de modelo**  
 \_\_\_\_\_

**Nº de serie**  
 \_\_\_\_\_

(1003-M06 plate bottom es 01)

Il numero di modello e quello di serie, i requisiti di alimentazione e altre informazioni del prodotto si trovano sulla piastrina o vicino alla stessa. La piastrina del prodotto si trova nella parte inferiore dell'unità. Annotare il numero di serie nello spazio indicato di seguito e conservare il manuale come documento di comprovazione dell'acquisto; in tal modo, in caso di furto, l'identificazione sarà più semplice.

**Numero del modello**  
 \_\_\_\_\_

**Numero di serie**  
 \_\_\_\_\_

(1003-M06 plate bottom it 01)

Le numéro de modèle, le numéro de série, l'alimentation requise, etc., se trouvent sur ou près de la plaque signalétique du produit, située dans la partie inférieure de l'unité. Notez le numéro de série dans l'espace fourni ci-dessous et conservez ce manuel en tant que preuve permanente de votre achat afin de faciliter l'identification du produit en cas de vol.

**Nº de modèle**  
 \_\_\_\_\_

**Nº de série**  
 \_\_\_\_\_

(1003-M06 plate bottom fr 01)

Номер модели, серийный номер, требования к источнику питания и пр. указаны на табличке с названием изделия в нижней части устройства или рядом с ней. Запишите серийный номер в расположенном ниже поле и сохраните данное руководство как подтверждение покупки; это поможет идентифицировать принадлежность устройства в случае кражи.

**Номер модели.**  
 \_\_\_\_\_

**Серийный номер.**  
 \_\_\_\_\_

(1003-M06 plate bottom ru 01)



# TA3 SH3 SC3 Owner's Manual

## Table of Contents

PRECAUTIONS .....	6
NOTICE.....	7
Information .....	8
<b>Main Features</b> .....	<b>9</b>
<b>Getting Started</b> .....	<b>10</b>
About the Manuals .....	10
Included Accessories .....	11
Part Names and Functions .....	12
<b>1 Preparing the Power Supply</b> .....	<b>14</b>
<b>2 Enjoy Playing the Piano</b> .....	<b>17</b>
Playing as an acoustic piano (Acoustic mode) .....	17
Playing with digital sounds using the headphones (Quiet mode) .....	18
Attaching the headphone hanger .....	19
Playing with digital sounds using soundboard resonance (TransAcoustic mode) <b>TA3 SH3 SC3</b> .....	20
Layering the digital sound with the acoustic piano sound (Layer mode) <b>TA3 SH3 SC3</b> .....	21
Selecting a Voice for playing with digital sound .....	22
Voice List.....	23
<b>3 Playing Back and Recording Songs</b> .....	<b>24</b>
Playing back Songs .....	24
Playback operations .....	27
Specifying the playback part (right-hand/left-hand) for a MIDI Song.....	28
Recording your performance .....	29
Basic procedure for recording (MIDI recording/Audio recording).....	29
Recording the right-hand and left-hand parts independently (MIDI recording) .....	31
Handling User Song files .....	34
Copying User Songs in internal memory to a USB flash drive .....	34
Deleting User Songs.....	35
Setting the appropriate Character Code for Song file names .....	37

<b>4 Other Important Functions (UTILITY)</b> .....	<b>38</b>
Using the metronome .....	38
Turning the metronome on/off .....	38
Adjusting the tempo .....	39
Selecting the time signature (beat) .....	39
Adjusting the metronome volume .....	40
Playing the piano along with Rhythm playback .....	41
Playing back a Rhythm.....	41
Rhythm List .....	42
Adjusting the Rhythm volume.....	43
Customizing with the various Function parameters .....	44
Basic Function-setting operations .....	44
Function List.....	45
Glossary of terms .....	53
Initializing the instrument (Clearing the Backup data).....	54
<b>5 Connecting to Other Devices</b> .....	<b>55</b>
Connecting USB devices ([USB TO DEVICE] terminal) ....	55
Precautions when using the [USB TO DEVICE] terminal ....	55
Using USB Flash Drives.....	55
Formatting a USB flash drive .....	56
Connecting to external audio devices.....	57
Output the digital sound of the instrument to an external device (AUX OUT jacks) <b>TA3 SH3 SC3</b> .....	57
Listening to Audio playback on an external device through this instrument ([AUX IN] jack).....	58
Listening to audio data played by a Bluetooth-equipped device through this instrument (Bluetooth Audio function) .....	59
Connecting with the smart device app “Smart Pianist” ....	61
Connecting via USB cables .....	61
Connecting via Bluetooth .....	61
Connecting via Wi-Fi (wireless LAN) .....	62
Connecting to a computer ([USB TO HOST] terminal) ....	63
Transmitting/receiving audio data (USB Audio Interface function).....	63
Turning Audio Loopback on/off .....	64
Connecting to a MIDI device (MIDI terminals) <b>TA3 SH3 SC3</b> .....	64
<b>Appendix</b> .....	<b>65</b>
Message List .....	65
Troubleshooting .....	67
Voice List.....	69
Song List.....	72
Voice Demo Songs.....	72
Preset Songs.....	73
Specifications .....	75
Index.....	77

# PRECAUTIONS

## PLEASE READ CAREFULLY BEFORE PROCEEDING

Especially in the case of children, a guardian should provide guidance on how to properly use and handle the product before actual use.

Please keep this manual in a safe and handy place for future reference.

## WARNING

**Always follow the basic precautions listed below to avoid the possibility of serious injury or even death from electrical shock, short-circuiting, damages, fire or other hazards. These precautions include, but are not limited to, the following:**

### Power supply

- Do not place the power cord near heat sources such as heaters or radiators. Also, do not excessively bend or otherwise damage the cord, or place heavy objects on it.
- Do not touch the product or the power plug during an electrical storm.
- Use only the correct voltage specified for the product. The required voltage is printed on the name plate of the product.
- Use only the supplied or the specified AC adaptor (page 76)/ power cord. Do not use the supplied AC adaptor/power cord for other products.
- Check the power plug periodically and remove any dirt or dust which may have accumulated on it.
- Insert the power plug firmly all the way into the AC outlet. Using the product when it is not plugged in sufficiently can cause dust to accumulate on the plug, possibly resulting in fire or skin burns.
- When setting up the product, make sure that the AC outlet you are using is easily accessible. If some trouble or malfunction occurs, immediately turn off the power switch and disconnect the plug from the outlet. Even when the power switch is turned off, as long as the power cord is not unplugged from the wall AC outlet, the product will not be disconnected from the power source.
- Do not connect the product to an electrical outlet using a multi-plug outlet extender. Doing so can result in lower sound quality, or possibly cause overheating in the outlet.
- When disconnecting the power plug, always hold the plug itself and not the cord. Pulling by the cord can damage it and cause electric shocks or a fire.
- If not using the product for long periods of time, be sure to pull the power plug from the AC outlet.

### Do not disassemble

- This product contains no user-serviceable parts. Do not attempt to disassemble the internal parts or modify them in any way.

### Water warning

- Do not expose the product to rain, use it near water or in damp or wet conditions, or place on it any containers (such as vases, bottles or glasses) containing liquids which might spill into any openings or places where water may drop. A liquid such as water getting into the product may cause a fire, electric shocks, or malfunctions.
- Use the AC adaptor indoors only. Do not use in any wet environments.
- Never insert or remove a power plug with wet hands.

### Fire warning

- Do not place any burning items or open flames near the product, since they may cause a fire.

### Wireless unit

- Radio waves from this product may affect electro-medical devices, such as a heart pacemaker implant or defibrillator implant.
  - Do not use the product near medical devices or inside medical facilities. Radio waves from this product may affect electro-medical devices.
  - Do not use the product within 15 cm (6 in.) of persons with a heart pacemaker implant or a defibrillator implant.

### Connections

- Be sure to read the manual of the device to be connected, and follow the instructions. Failure to observe this may cause a fire, overheating, explosion, or malfunction.

### If you notice any abnormality

- If any of the following problems occur, immediately turn off the power switch and disconnect the power plug from the outlet.  
Finally have the device inspected by Yamaha service personnel.
  - The power cord or plug becomes frayed or damaged.
  - Unusual smells or smoke are emitted.
  - Some object, or water has been dropped into the product.
  - There is a sudden loss of sound during use of the product.
  - Cracks or other visible damage appear on the product.

## CAUTION

Always follow the basic precautions listed below to avoid the possibility of physical injury to you or others, or damage to the product or other property. These precautions include, but are not limited to, the following:

### Location

- Before placing or moving the piano, consult with a specialist experienced in handling pianos. Pianos are extremely heavy, so one must be careful to avoid back injury or scratching the floor when moving it. Before moving the piano, remove all connected cables to prevent damage to the cables or injury to anyone who might trip over them.

### Connections

- Before connecting the product to other electronic components, turn off the power for all components. Before turning the power on or off for all components, set all volume levels to minimum.
- Be sure to set the volumes of all components at their minimum levels and gradually raise the volume controls while playing the product to set the desired listening level.

### Handling

- Do not use excessive force on the buttons, switches or connectors.
- Keep small parts out of the reach of infants. Your children may accidentally swallow them.
- Do not use the product or headphones for a long period of time at a high or uncomfortable volume level, since this can cause permanent hearing loss. If you experience any hearing loss or ringing in the ears, consult a physician.
- Remove the power plug from the AC outlet before cleaning the unit. Failure to observe this may cause electric shocks.

Yamaha cannot be held responsible for damage caused by improper use or modifications to the product, or data that is lost or destroyed.

Always turn the power off when the product is not in use. Even when the [⏻] (Standby/On) switch is in standby status (power lamp is off), electricity is still flowing to the product at the minimum level.

When you are not using the product for a long time, make sure you unplug the power cord from the wall AC outlet.

(DMI-10)

## NOTICE

To avoid the possibility of malfunction/ damage to the product, damage to data, or damage to other property, follow the notices below.

### ■ Handling

- Do not connect this product to a public Wi-Fi and/or Internet service directly. Only connect this product to the Internet through a router with strong password protections. Consult your router manufacturer for information on optimum security practices.
- Do not use the instrument in the vicinity of a TV, radio, stereo equipment, mobile phone, or other electric devices. Otherwise, the instrument, TV, or radio may generate noise.
- When you use the instrument along with an app on your smart device, such as a smartphone or tablet, we recommend that you enable “Airplane Mode” on the device to avoid noise caused by communication. When wirelessly connecting a smart device with this product, make sure that the Wi-Fi or *Bluetooth*® setting on the device is turned on.
- Do not expose the instrument to excessive dust or vibrations, or extreme cold or heat (such as in direct sunlight, near a heater, or in a car during the day) to prevent the possibility of disfiguration, damage to the internal components or unstable operation.

### ■ Maintenance

- When cleaning the instrument, use a soft and dry/slightly damp cloth. Do not use paint thinners, solvents, alcohol, cleaning fluids, or chemical-impregnated wiping cloths.

### ■ Saving data

- Some of the data of this product (page 54) are retained when the power is turned off. However, the saved data may be lost due to some failure, an operation mistake, etc. Save your important data onto USB flash drive/an external device such as a computer (pages 34, 63).
- To protect against data loss through USB flash drive damage, we recommend that you save your important data onto spare USB flash drive or an external device such as a computer as backup data.

# Information

## ■ About copyrights

- The copyright of the “content”<sup>\*1</sup> installed in this product belongs to Yamaha Corporation or its copyright holder. Except as permitted by copyright laws and other relevant laws, such as copying for personal use, it is prohibited to “reproduce or divert”<sup>\*2</sup> without the permission of the copyright holder. When using the content, consult with a copyright expert.

If you create music or perform with the contents through the original use of the product, and then record and distribute them, the permission of Yamaha Corporation is not required regardless of whether the distribution method is paid or free of charge.

\*1: The word “content” includes a computer program, audio data, Accompaniment Style data, MIDI data, waveform data, voice recording data, music score, and score data, etc.

\*2: The phrase “reproduce or divert” includes taking out the content itself in this product, or recording and distributing it without changes in a similar manner.

## ■ About functions/data bundled with the instrument

- Some of the preset Songs have been edited for length or arrangement, and may not be exactly the same as the original.

## ■ About this manual

- The illustrations as shown in this manual are for instructional purposes only.
- Windows is a registered trademark of Microsoft® Corporation in the United States and other countries.
- Wi-Fi is a registered trademark of Wi-Fi Alliance®.
- The Bluetooth® word mark and logos are registered trademarks owned by Bluetooth SIG, Inc. and any use of such marks by Yamaha Corporation is under license.



- The company names and product names in this manual are the trademarks or registered trademarks of their respective companies.

## ■ About Bluetooth®

Bluetooth is a technology for wireless communication between devices within an area of about 10 meters (33 ft.) employing the 2.4 GHz frequency band.

### Handling Bluetooth communications

- The 2.4 GHz band used by Bluetooth compatible devices is a radio band shared by many types of equipment. While Bluetooth compatible devices use a technology minimizing the influence of other components using the same radio band, such influence may reduce the speed or distance of communications and in some cases interrupt communications.
- The speed of signal transfer and the distance at which communication is possible differs according to the distance between the communicating devices, the presence of obstacles, radio wave conditions and the type of equipment.
- Yamaha does not guarantee all wireless connections between this unit and devices compatible with Bluetooth function.

### Bluetooth capability

Depending on the country in which you purchased the product, the instrument may not have Bluetooth capability. If a Bluetooth unit is installed at the bottom of the control unit, this means that the product is equipped with Bluetooth functionality.

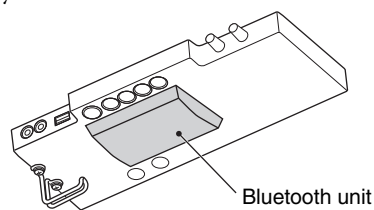



# Main Features

## What is the TransAcoustic™ Piano?

The TransAcoustic™ Piano is an acoustic piano that allows the player to adjust the volume through the use of Yamaha's innovative TransAcoustic technology. When in the TransAcoustic mode, the soundboard of the piano amplifies the built-in digital sounds and produces the same natural resonance found on an acoustic piano. The technology enables you to play with the authentic touch and feel of an actual acoustic piano, and yet have control over the volume. You can also play this instrument as a conventional acoustic piano, and can switch it to the Quiet mode, just as on the SILENT Piano™ below, and listen to the sound through the headphones.

## What is the SILENT Piano™?

The SILENT Piano™ is an acoustic piano equipped with Yamaha's original muting technology. While in the Quiet mode, the hammers stop just before striking the strings when keys are pressed, and no sound is emitted from the piano. The sensors accurately detect the movement of the keys, and the keystroke data activates the built-in digital tone generator for producing sound that is then output from the headphones. This lets you play or practice any time you want, without worrying about your surroundings or disturbing others nearby. It can also be used as a conventional acoustic piano.

Both the TransAcoustic™ Piano and SILENT Piano™ provide you with highly useful and advanced functions as described below for enhancing your life with music.



### Variety of Voices including the Yamaha CFX concert grand piano

▶▶ page 22

This instrument features piano sounds created with samples of the Yamaha CFX flagship concert grand piano and the famed Vienna-made Bösendorfer grand piano. The sound of the Yamaha CFX is powerful, sparkling and with a rich bass resonance. As an alternative, the Bösendorfer sound is soft and deep in the mid to bass range and beautiful for pianissimo parts. Along with these two gorgeous piano sounds, a variety of other Voices are provided—allowing you to select the instrument sound that best matches the music you want to play.

\* Bösendorfer is a subsidiary company of Yamaha.



### Realistic feeling of being immersed in the sound—even when using headphones

▶▶ page 18

When playing with the binaural-sampled sounds of the CFX or Bösendorfer Voices, you feel yourself immersed in the sound as if it was actually emanating from the piano—even when listening through the headphones. The other piano Voices also provide the sense of a natural sound distance.



### Preset Songs for efficient practicing

▶▶ page 24

50 classical music masterpieces are built into this instrument. You can simply enjoy listening to these built-in Songs, or use them for one-hand practice by separately playing back the right-hand or left-hand parts as desired.



### Recording and playing back your performance

▶▶ page 29

The instrument lets you record your performance to internal memory or a USB flash drive. Listening back to your recordings helps immensely in improving your performance.



### Simple Rhythm Patterns to play along with

▶▶ page 41

A variety of simple rhythm patterns (drums and bass accompaniment) are provided, letting you enjoy playing the piano along with dynamic Rhythm playback.



### Convenient smart device compatibility

▶▶ page 61

Connect this instrument to a smart device, such as smart phone or tablet, and use it with the compatible Smart Pianist app. It enables convenient operations such as selecting Voices, controlling the metronome intuitively with the visual interface, or displaying the score of the preset Songs on your smart device.

# Getting Started

Thank you for purchasing this Yamaha piano! This is an acoustic piano equipped with a control unit and other devices, enabling you to play the piano just like an acoustic piano, but also with the modern conveniences of digital sound. It lets you enjoy a wide variety of functions such as selecting different Voices, playing back Songs, or recording your own performances. In order to make the most of your piano's performance potential and features, please read this Owner's Manual thoroughly, and keep it in a safe place for later reference.

## About the Manuals

This instrument has the following manuals.



### Supplied with the instrument

#### ● TA3/SH3/SC3 Owner's Manual (this book)

Explains the functions of TransAcoustic™ Piano (TA3) and SILENT Piano™ (SH3 or SC3) and how to use them. Since all functions for multiple models are explained in this single book, specific functions mentioned here may not be available on your piano. Make sure to understand the instructions below beforehand, and then read the manual while checking whether or not the function is available on your piano.

#### To confirm the model name:

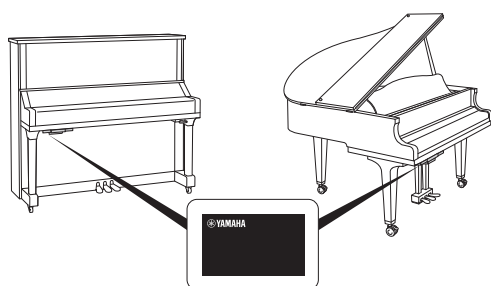

The model number can be found on or near the name plate, which is at the bottom of the control unit as shown in the illustration. Confirm the model name first since the availability of functions differs depending on the model.

XXX \*\* TA3



The last three letters (TA3, SH3, or SC3) indicate the model name. Other letters indicate the model number of the piano.

#### To confirm available functions:

In this manual, each function's instructions have icons that indicate which model is compatible with the function. This example indicates that the relevant function is available on the TA3 (TransAcoustic™ Piano) but not on the SH3 or SC3 (SILENT Piano™).

Example: **TA3** SH3 SC3

#### Rules for the notes

 <b>WARNING</b>	Important information to avoid the possibility of serious injury or even death from electrical shock, short-circuiting, damages, fire or other hazards.
 <b>CAUTION</b>	Important information to avoid the possibility of physical injury to you or others, or damage to the instrument or other property.
<b>NOTICE</b>	Important information to avoid the possibility of malfunction/ damage to the product, damage to data, or damage to other property.
<b>NOTE</b>	Helpful information and tips.



## Available on the website

### ● **Smart Pianist User Guide**

Explains how to set up and use a smart device with the dedicated Smart Pianist app (page 61) for controlling this instrument.

### ● **Computer-related Operations**

Includes instructions on connecting this instrument to a computer, and other operations. Read this along with page 63 of this Owner's Manual.

### ● **MIDI Reference**

Contains MIDI-related information for this instrument.

To obtain these manuals, access the Yamaha website below:

#### **Yamaha Downloads**

<https://download.yamaha.com/>



Enter the model name for searching the desired manuals.

## Included Accessories

---

- TA3/SH3/SC3 Owner's Manual (this book) ×1
- "50 Classical Music Masterpieces" (Music Book) ×1 (TA3/SH3 only)
- Headphones ×1
- Headphone hanger ×1 (see page 19)
- Attachment screws for headphone hanger ×2 (see page 19)
- AC adaptor\* ×1
- Power cord\* ×1

\* May not be included depending on your area. Check with your Yamaha dealer.

# Part Names and Functions

The control unit lets you operate the functions of the TransAcoustic™ Piano and SILENT Piano™. The silencing lever or silencing pedal (center pedal) is also used on some piano models.

## Upright piano

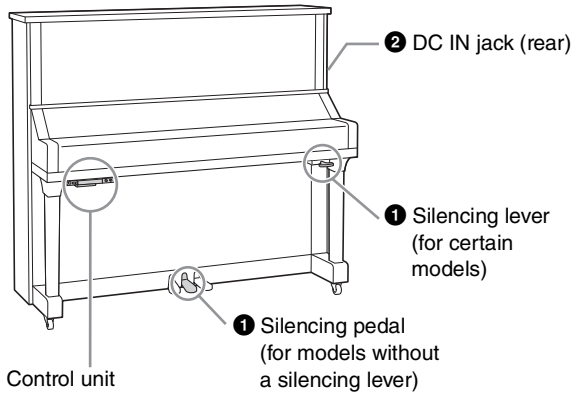

## Grand piano

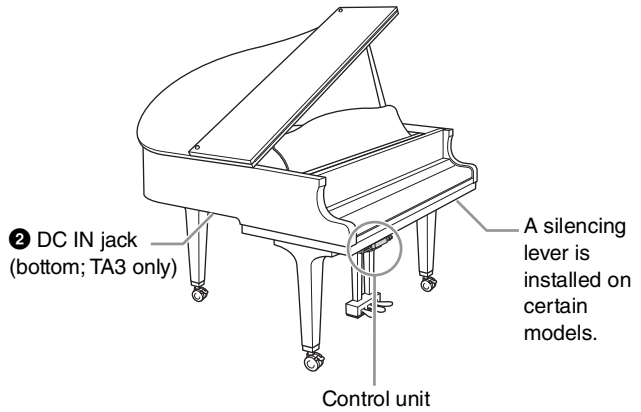

## Control unit

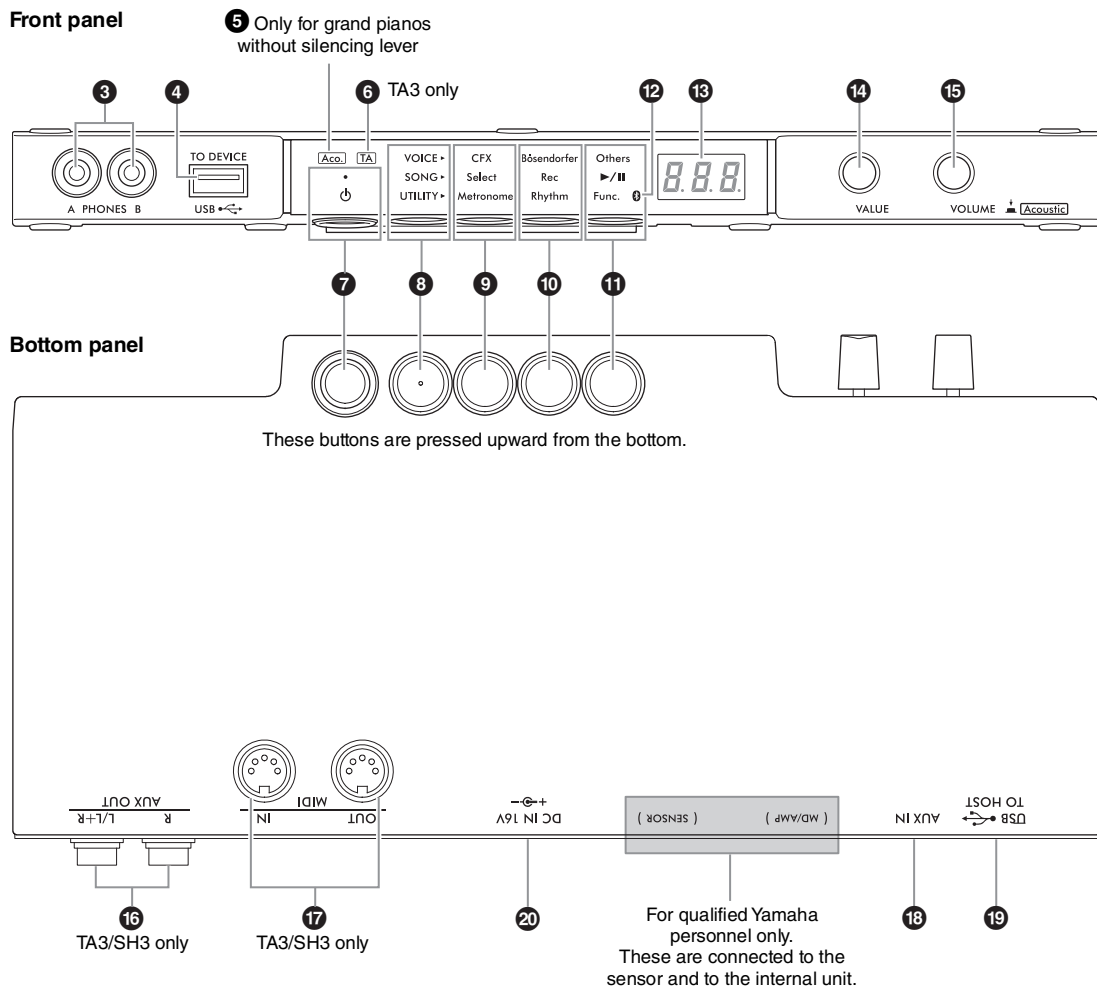

**1 Silencing lever/Silencing pedal . . . page 18**

Turns the acoustic piano sound on/off. For upright pianos, a silencing lever or silencing pedal is installed for control over this function. For grand pianos, most models do not include these, and only one specific model is equipped with the silencing lever.

**2 DC IN jack . . . . . pages 14, 15**

For connecting the power cord and the AC adaptor. This jack is not installed on the SH3 and SC3 grand pianos.

**3 [PHONES] jacks . . . . . page 18**

For connecting headphones.

**4 [USB TO DEVICE] terminal. . . . . page 55**

For connecting a USB flash drive or a USB wireless LAN adaptor (sold separately).

**5 [Aco.] lamp. . . . . page 17**

For grand pianos not equipped with a silencing lever, this lamp lights up when the Acoustic mode is enabled.

**6 [TA] lamp . . . . . pages 20, 21**

TA3 SH3 SC3

This lamp lights to indicate that the instrument is in the TransAcoustic mode or Layer mode.

**7 [ϕ] (Standby/On) switch . . . . . page 15**

For turning the power on or setting it to standby.

**8 Menu button**

Each time you press this button, VOICE, SONG or UTILITY is selected and its lamp lights up in orange.

• **VOICE . . . . . page 22**

For selecting a Voice.

• **SONG . . . . . page 24**

For controlling Songs, such as playing back the preset Songs or recording your own performance.

• **UTILITY . . . . . page 38**

For using the metronome, playing back a rhythm, or making various settings.

**9 Button 1/10 Button 2/11 Button 3**

Depending on the selection made from VOICE/SONG/UTILITY by using the Menu button, different functions are assigned and can be controlled by pressing the respective button.

**12 Bluetooth lamp . . . . . page 59**

Lights up when the Bluetooth function is on. It lights up in blue when the unit is connected with a Bluetooth-equipped device, or in white when no Bluetooth-equipped device is connected, and UTILITY is selected.

**13 Display**

Indicates the Voice number, Song number, other parameter values, or messages. For a list of messages, see page 65.

Parameter value

Message



**14 [VALUE] control**

For selecting items or setting values.

**15 [VOLUME] control**

For adjusting the volume of the sound by rotating the control. The volume of the performance in the Quiet mode, TransAcoustic mode and Layer mode (page 17), as well as the volume of the sound output to an external device (pages 57, 63, 64) can be adjusted. On the grand pianos without a silencing lever, pressing the control can turn the Acoustic mode on/off (page 17).

**16 AUX OUT [R]/[L/L+R] jacks . . . . . page 57**

TA3 SH3 SC3

For connecting to and outputting this instrument's sound to an external audio device, such as powered speakers.

**17 MIDI [IN]/[OUT] terminals. . . . . page 64**

TA3 SH3 SC3

For connecting an external MIDI device.

**18 [AUX IN] jack. . . . . page 58**

For connecting to an external audio device, such as a portable audio player, for inputting the sound from that device to this instrument.

**19 [USB TO HOST] jack . . . . . page 63**

For connecting to a computer or smart device, such as a smartphone or tablet.

**20 [DC IN 16V] jack**

For the SH3 and SC3 grand pianos, connect the power cord and the AC adaptor to this jack (page 15). For upright pianos and the TA3 grand pianos, only qualified Yamaha personnel should handle this jack. The plug is already connected when the instrument is shipped.

# 1

## Preparing the Power Supply

In order to use the special functions on the TransAcoustic™ Piano or the Silent Piano™, the power to the instrument must be turned on. If you are using the instrument as a conventional acoustic piano, it is not necessary to turn on the power.

### 1 Connect the plugs of the AC adaptor and power cord.

The connection method differs depending on the instrument.

#### **⚠ WARNING**

- Use the specified adaptor (page 76) only. Using the wrong AC adaptor can result in damage to the instrument or overheating.
- When setting up the product, make sure that the AC outlet you are using is easily accessible. If some trouble or malfunction occurs, immediately turn the power off and disconnect the plug from the outlet.

#### **NOTE**

When disconnecting the power cord/AC adaptor, first turn off the power, and then follow this procedure in reverse order.

#### • For upright pianos:

**TA3 SH3 SC3**

Connect the plugs to the DC IN jack (DC IN 24V or DC IN 16V) located at the rear of the piano, and to the AC outlet in the order shown in the illustration. Use the provided hooks to hold and organize any excess cord.

\* Depending on the specific model, the connection method may differ.

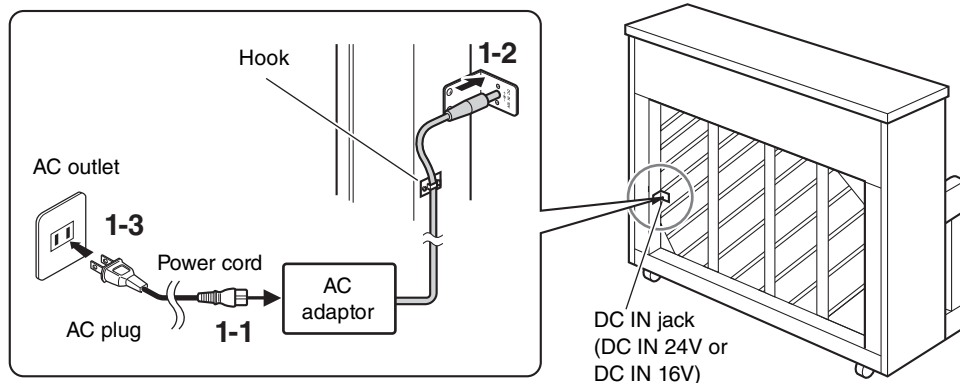

The shape of the plug and outlet may differ depending on your locale.

# 1 • For grand pianos:

TA3 SH3 SC3

Connect the plugs to the DC IN jack (DC IN 24V) located at bottom the piano, and to the AC outlet in the order shown in the illustration. If you desire a cleaner installation, you can attach the AC adaptor to the adaptor holder which is located at behind the control unit.

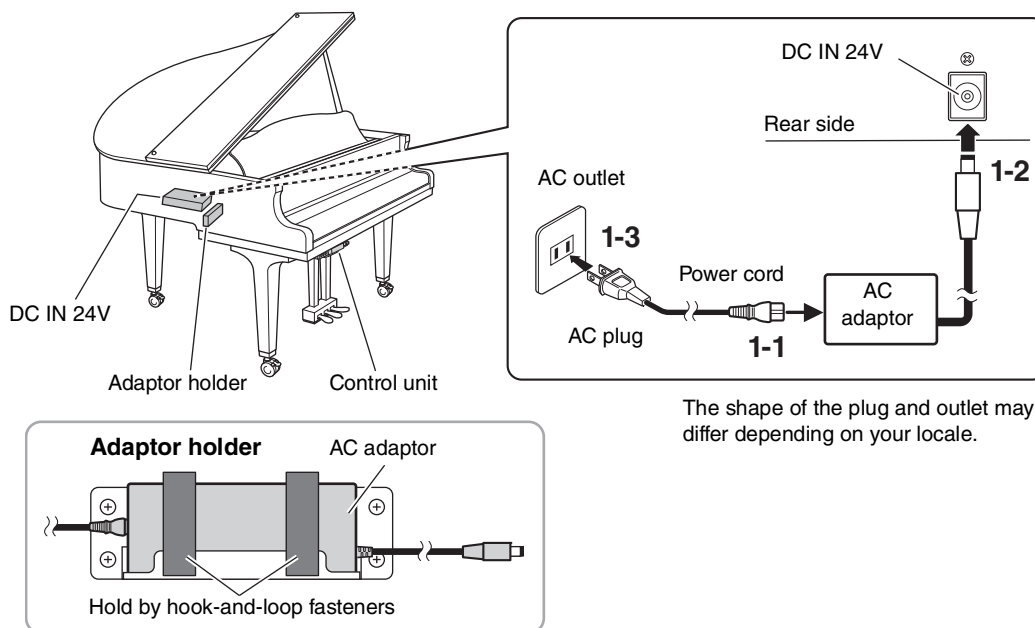

# • For grand pianos:

TA3 SH3 SC3

Connect the plugs of the AC adaptor to the [DC IN 16V] jack on the control unit in the order shown in the illustration. If you desire a cleaner installation, you can attach the AC adaptor to the adaptor holder (see the illustration above), and also use the hooks to hold excess cord. The adaptor holder and the hooks are located behind the control unit.

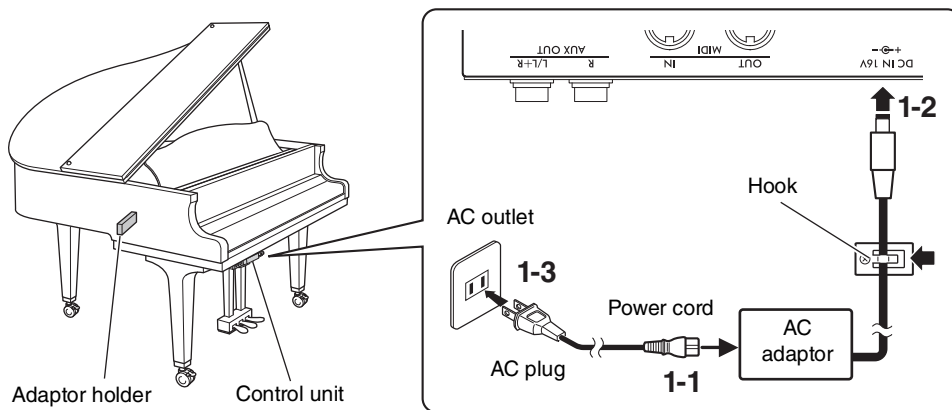

# 2 Press the [⏻] (Standby/On) switch on the control unit to turn the power on.

The power lamp and the display light. To turn the power off, press the switch again.

**NOTICE**

Press only the [⏻] (Standby/On) switch when turning the power on. Any other operations, such as pressing the keys, buttons or pedals may cause the instrument to malfunction.

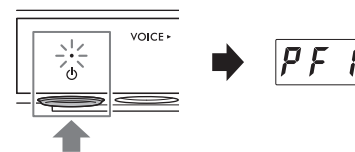

**CAUTION**

Even when the power is turned off, electricity is still flowing to the instrument at the minimum level. Remove the electric plug from the outlet when the instrument is not to be used for extended periods of time, or during electrical storms.

## Auto Power Off function

TA3 SH3 SC3

To prevent unnecessary power consumption, this instrument features an Auto Power Off function that automatically turns the power off if the instrument is not operated for approximately 30 minutes. This function is enabled by default.

### NOTICE

When the instrument is communicating with other devices or Songs are being played back, the power will not be turned off automatically. Make sure to turn off the power by pressing the [⏻] (Standby/On) switch when the instrument is not in use.

### Disabling the Auto Power Off function:

Turn the power on while holding down the lowest key. “PoF” appears on the display and the unit starts up with the Auto Power Off function disabled.

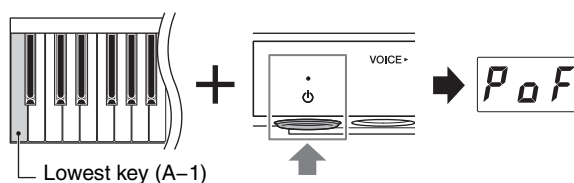

### NOTE

You can also disable the Auto Power Off function by turning the power on while holding down the Menu button. To enable or disable the Auto Power Off function while the power is on, set it in Function F8.1 (page 52).



# Enjoy Playing the Piano

This instrument can be played in the following modes depending on the circumstances and your personal preferences.

TA3 SH3 SC3

- **Acoustic mode:** You can play as a normal acoustic piano (see below).
- **Quiet mode:** You can play with the acoustic piano sound muted and listen to a digital sound through the headphones (page 18).

TA3 SH3 SC3

- **TransAcoustic mode:** You can play with a digital sound and hear it through the resonance of the piano soundboard by means of TransAcoustic technology (page 20). The acoustic piano sound is muted.
- **Layer mode:** You can play with a digital sound layered over the acoustic piano sound (page 21).

When the instrument is in the Quiet mode, TransAcoustic mode, or Layer mode, you can use various functions such as playing with preset Voices or recording your performances. These functions can be used only when the power is turned on. If you simply want to play in the Acoustic mode, turning on the power is not necessary.

## Playing as an acoustic piano (Acoustic mode)

TA3 SH3 SC3

If you want to play the instrument as a normal acoustic piano, turning on the power is not necessary; simply play the piano with the power turned off. If you are using an upright piano, or a grand piano equipped with a silencing lever, make sure that the silencing lever or the silencing pedal is in the following position.

### ◆ For pianos with a silencing lever:

Pull the silencing lever forward to return it to the back position.

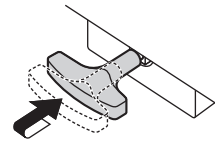

### ◆ For upright pianos without a silencing lever:

Press the silencing pedal (center pedal) to slide it to the right.

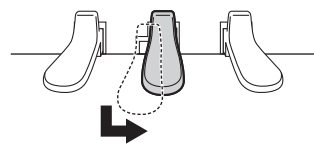

### ◆ For grand pianos without a silencing lever:

No operations are required.

While the power is turned on, pressing the [VOLUME] control lights up the [Aco.] lamp and enables you to play with acoustic sound. In this condition, the Voice is automatically set to "---" (page 22).

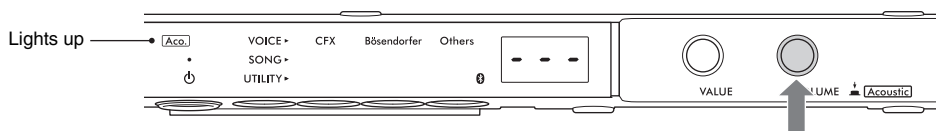

### NOTE

- Pressing the [VOLUME] control again turns off the [Aco.] lamp and switches the instrument to the Quiet mode (page 18).
- (TA3 only) If you select a Voice other than "---", both the [Aco.] and [TA] lamps light, indicating that the instrument is in the Layer mode (page 21).

# Playing with digital sounds using the headphones (Quiet mode)

TA3 SH3 SC3

This lets you play with the acoustic piano sound muted and listen to the digital sound through the headphones. In this condition, no piano sound can be heard from the instrument. The movement of the keys is detected by the sensors and transmitted to the tone generator, and then the sound is output from the headphones.

## NOTE

The physical sound of the keyboard mechanism remains even when playing in the Quiet mode.

- 1 Rotate the [VOLUME] control to the far-left position to set the volume to minimum.

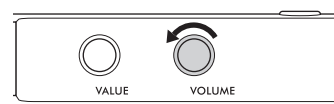

- 2 Press the [⏻] (Standby/On) switch to turn the power on.

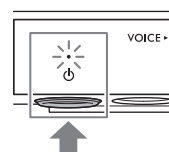

- 3 Stop the acoustic piano sound (or activate the Quiet mode) by one of the following operations.

### ◆ For pianos with a silencing lever:

Pull the silencing lever towards you until you hear a click and feel the mechanism catch.

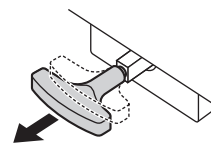

### ◆ For upright pianos without a silencing lever:

Press the silencing pedal (center pedal) and slide it to the left until it is locked in that position.

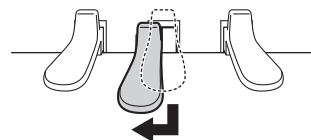

### ◆ For grand pianos without a silencing lever:

Make sure that the [Aco.] lamp is turned off. If the lamp is lit, press the [VOLUME] control to turn it off.

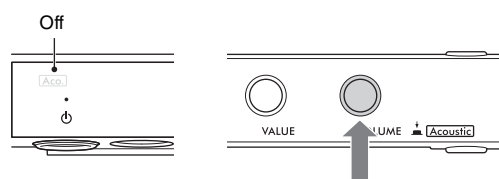

- 4 Plug the headphones into the [PHONES] jack.

You can connect a pair of headphones to each of the two jacks. If you are using only one pair, insert the plug into either of these jacks.

### ⚠ CAUTION

Do not use the headphones for a long period of time at a high or uncomfortable volume level, since this can cause permanent hearing loss.

### NOTICE

Do not pull the cord of the headphones or apply excessive force on the plug. This can damage the headphones or the control unit and result in sound degradation.

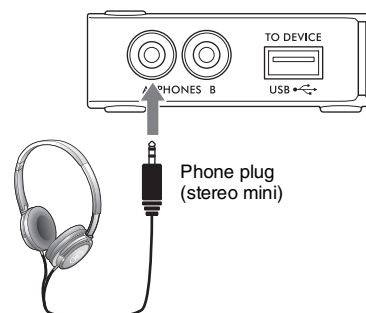

## 5 While playing the keyboard, adjust the volume level by rotating the [VOLUME] control.

Decreases the level.      Increases the level.

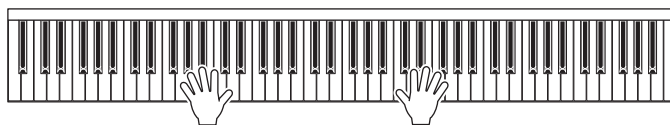
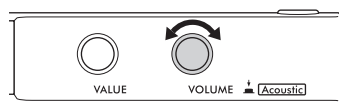

### Reproducing a natural sound distance sensation (even when using headphones) — Binaural Sampling and Stereophonic Optimizer

This instrument features two advanced technologies that allow you to enjoy exceptionally realistic, natural piano sound, even when listening on headphones.

#### ■ Binaural Sampling

Binaural Sampling is a method that uses two special microphones set at the ear position of a performer and records the sound from a piano as it would actually be heard. Listening to the sound with this effect through headphones gives the impression of being immersed in the sound, as if it was actually emanating from the piano. Moreover, you can enjoy the sound naturally for a long time without ear fatigue. When “CFX Grand” (PF1) or “Bösendorfer” (PF2) is selected (page 22), connecting the headphones automatically enables binaural sampling sound.

#### Sampling

A technology which records the sounds of an acoustic instrument then stores them to the tone generator to be played based on information received from the keyboard.

#### ■ Stereophonic Optimizer

Stereophonic Optimizer is an effect which reproduces natural sound distance as with the sound of Binaural Sampling, even when listening on headphones. When one of the Piano Voices besides “CFX Grand” or “Bösendorfer” (PF3–PF5) is selected, connecting the headphones automatically enables the Stereophonic Optimizer.

This function is turned on by default. Since these sounds are optimized for listening with headphones, we recommend that you set this function to “Off” in the following situations. (The On/Off setting can be changed in Function F4.1; page 49.)

- Playing the digital sound of this instrument through the connected external device (page 57), while listening to the sound from the headphones connected to this instrument.
- Making an audio recording (page 29) while using headphones, and then listening to that recorded audio Song without using headphones.

#### NOTE

Before connecting an external device, be sure to read “Connecting to Other Devices” (page 55).

## Attaching the headphone hanger

Attach the headphone hanger to the bottom of the control unit with the supplied two screws.

#### NOTICE

Do not hang anything other than the headphones on the hanger. Otherwise, the control unit or the hanger may be damaged.

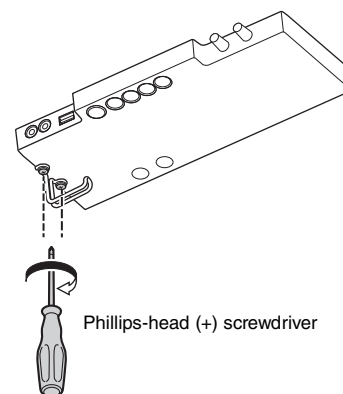

# Playing with digital sounds using soundboard resonance (TransAcoustic mode)

TA3 SH3 SC3

This lets you play the digital sounds and hear them through the resonance of the piano soundboard by means of TransAcoustic technology. In this condition, no piano sound can be heard from the instrument.

## NOTE

The physical sound of the keyboard mechanism remains even when playing in the TransAcoustic mode.

- 1 Rotate the [VOLUME] control to the far-left position to set the volume to minimum.

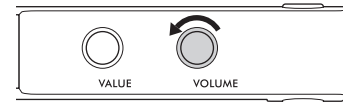

- 2 Press the [⏻] (Standby/On) switch to turn the power on.

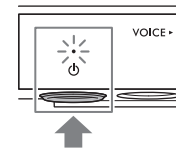

- 3 Disable the acoustic piano sound (or activate the Quiet mode) by one of the following operations.

### ◆ For pianos with a silencing lever:

Pull the silencing lever towards you until you hear a click and feel the mechanism catch.

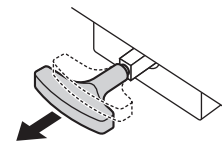

### ◆ For upright pianos without a silencing lever:

Press the silencing pedal (center pedal) and slide it to the left until it is locked in that position.

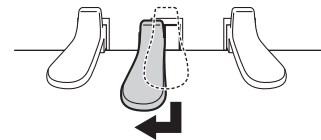

### ◆ For grand pianos without a silencing lever:

Make sure that the [Aco.] lamp is turned off. If the lamp is lit, press the [VOLUME] control to turn it off.

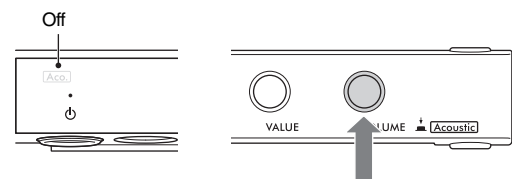

- 4 Rotate the [VOLUME] control to the right so that the [TA] lamp lights, indicating the TransAcoustic mode is enabled.

## NOTE

When the volume is set to minimum, when the Voice is set to "---" (page 22), or when headphones are plugged in, the TransAcoustic mode cannot be activated. Select a Voice other than "---," and unplug the headphones.

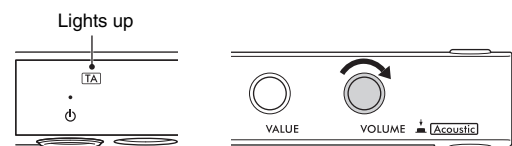

## 5 While playing the keyboard, adjust the volume level by rotating the [VOLUME] control.

Decreases the level.      Increases the level.

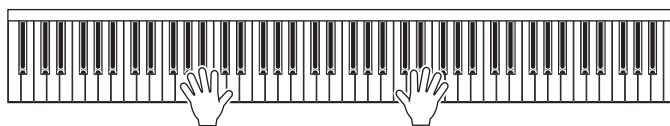
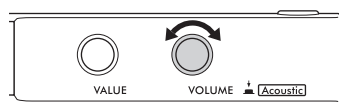

## Layering the digital sound with the acoustic piano sound (Layer mode)

TA3 SH3 SC3

With the Layer mode, you can play a digital sound layered over the acoustic piano sound. To enable the Layer mode, generally follow the steps of TransAcoustic mode on page 20, but make sure to turn on the acoustic piano sound in step 3 as shown below. Also, make sure a Voice other than “---” is selected (page 22).

### 3 ◆ For pianos with a silencing lever or silencing pedal:

Return the silencing lever or the silencing pedal back to the Acoustic mode position (page 17).

### ◆ For grand pianos without a silencing lever:

Press the [VOLUME] control to turn the [Aco.] lamp on.

#### NOTE

- This instrument is expertly tuned before it is shipped. However, the pitch may gradually go out of tune, depending on circumstances such as temperature and humidity. When you detect a difference between the pitch of the digital sound and acoustic piano sound, tune the piano mechanism, or adjust the Master Tune for the digital sound in the Function F3.4 (page 47). For tuning, consult a professional piano technician.
- The volume of the acoustic piano sound cannot be adjusted by using the [VOLUME] control.

# Selecting a Voice for playing with digital sound

TA3 SH3 SC3

When in the Quiet mode, TransAcoustic mode, or Layer mode, you can play various preset Voices on the piano. For information on available Voices, refer to the “Voice List” on page 23.

## 1 Press the Menu button several times until the [VOICE] lamp lights up in orange.

The currently selected Voice number is shown on the display.

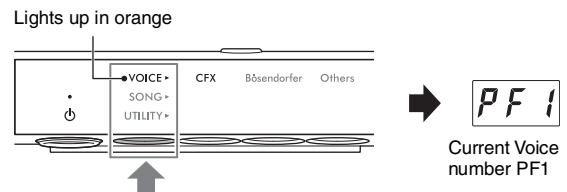

## 2 Use the [VALUE] control or one of the Buttons 1 – 3 to select the desired Voice.

The selected Voice can be confirmed by the lamp and the display.

### ◆ [VALUE] control

Rotating the control step by step switches the Voice to the next or previous one in the order of the Voice List. Pressing this control instantly selects the CFX Grand (PF1) Voice.



### ◆ Button 1 [CFX]

Pressing this button selects the CFX Grand (PF1) Voice.

### ◆ Button 2 [Bösendorfer]

Pressing this button selects the Bösendorfer (PF2) Voice.

### ◆ Button 3 [Others]

Pressing this button selects the first Voice in each category in order.

While the power is on, the Voice last selected by Button 3 [Others] is retained. Pressing Button 3 [Others] allows you to call up the last selected Voice instantly. When the power is turned off, the Voice for Button 3 resets to “PF3.”

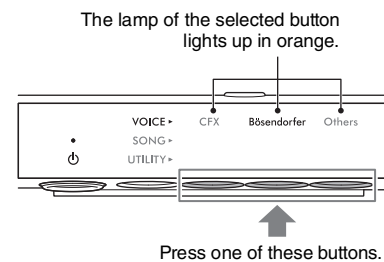

### NOTE

Listen to the Demo Songs for each Voice to hear and experience the characteristics of the Voices (page 24).

## Setting the Voice to “---” (Muting the digital sound)

Pressing the [VOLUME] control sets the Voice to “---,” allowing you to play the keyboard without producing any digital sound. However, other functions can be used. This setting can be used in situations such as playing an acoustic piano sound while using the Rhythm function (page 41) or recording function (page 29). You can also select “---” by rotating the [VALUE] control.

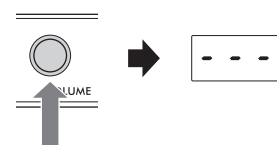

### NOTE

For grand pianos without the silencing lever, “---” can be selected only when the [Aco.] lamp is lit.

By default, the CFX Grand Voice (PF1) is selected when the power is turned on. When the Voice Backup function is set to on in Function F7.3 (page 51), the last selected Voice before the power was turned off will be called up when you turn the power on next time.

## Voice List

For details on each Voice, refer to page 69.

TA3	SH3	SC3	
Button	Display	Voice Name	
Button 1 [CFX]	<i>PF 1</i>	CFX Grand (Binaural CFX Grand*)	
Button 2 [Bösendorfer]	<i>PF 2</i>	Bösendorfer (Binaural Bösendorfer*)	
Button 3 [Others]	<i>PF 3</i>	Pop Grand	
	<i>PF 4</i>	Ballad Grand	
	<i>PF 5</i>	Upright Piano	
	<i>FP 1</i>	Scarlatti Piano	
	<i>FP 2</i>	Mozart Piano	
	<i>FP 3</i>	Beethoven Piano	
	<i>FP 4</i>	Chopin Piano	
	<i>EP 1</i>	Stage E.Piano	
	<i>EP 2</i>	DX E.Piano	
	<i>EP 3</i>	Vintage EP	
	<i>HS 1</i>	Harpichord 8'	
	<i>HS 2</i>	Harpsi. 8'+4'	
	<i>HS 3</i>	Vibraphone	
	<i>HS 4</i>	Celesta	
	<i>Or 1</i>	Organ Principal	
	<i>Or 2</i>	Organ Tutti	
	<i>Or 3</i>	Jazz Organ	
	<i>Pd 1</i>	Strings	
	<i>Pd 2</i>	Choir	
	<i>Pd 3</i>	Synth Pad	
	<i>LY 1</i>	Piano + Strings	
	<i>LY 2</i>	Piano + Pad	
	<i>LY 3</i>	Piano + DX E.Piano	
	—	- - -	(No digital sound)

TA3	SH3	SC3	
Button	Display	Voice Name	
Button 1 [CFX]	<i>PF 1</i>	CFX Grand (Binaural CFX Grand*)	
Button 2 [Bösendorfer]	<i>PF 2</i>	Bösendorfer (Binaural Bösendorfer*)	
Button 3 [Others]	<i>PF 3</i>	Upright Piano	
	<i>EP 1</i>	Stage E.Piano	
	<i>EP 2</i>	DX E.Piano	
	<i>EP 3</i>	Vintage EP	
	<i>HS 1</i>	Harpichord 8'	
	<i>HS 2</i>	Celesta	
	<i>Or 1</i>	Organ Principal	
	<i>Or 2</i>	Jazz Organ	
	<i>Pd 1</i>	Strings	
	<i>Pd 2</i>	Synth Pad	
	—	- - -	(No digital sound)

\* When Function F4.1 (Binaural) is set to on (page 49), connecting the headphones automatically enables Binaural Sampling sound for the PF1 (CFX Grand) or PF2 (Bösendorfer) Voice.

The preset songs, your recorded performances, and commercially available songs are referred to as “Songs” in this manual. This instrument allows you to play or record both MIDI Songs and Audio Songs.

## • MIDI Songs

A MIDI Song is comprised of your keyboard performance information and is not a recording of the actual sound itself. The performance information refers to which keys are played, at what timing, and at what strength—just as in a musical score. Based on the recorded performance information, the tone generator outputs the corresponding sound. This instrument can play back MIDI Songs in the SMF (Standard MIDI File) format (file extension: .mid).

## • Audio Songs

An Audio Song is a recording of the performed sound itself. This data is recorded in the same way as that used with voice recorders, etc. Just as with a smartphone or portable music player, etc., this instrument can play back the Audio Songs in the WAV format (file extension: .wav with 44.1 kHz/16-bit resolution, stereo).

## Playing back Songs

TA3 SH3 SC3

### Song Category (Songs that can be played)

Song Category		Song No.	Description
Voice Demo (MIDI)	<i>d.</i>	d.01–d.25/ d.01–d.12	Demo Songs which effectively demonstrate each Voice on this instrument (page 72).
Preset (MIDI)	<i>P.</i>	P.01–P.50	50 classical piano preset Songs stored to this instrument (page 73).
USB flash drive*	User (Audio)	<i>R.</i>	A.00–A.99 Audio Songs which have been recorded with this instrument and saved to a USB flash drive (page 29).
	External (Audio)	<i>E.</i>	C.00–C.99, 100–399 External Audio Songs, commercially available or which have been recorded on a computer, etc. and saved to a USB flash drive.
	User (MIDI)	<i>S.</i>	S.00–S.99 MIDI Songs which have been recorded with this instrument and saved to a USB flash drive (page 29).
	External (MIDI)	<i>F.</i>	F.00–F.99, 100–399 External MIDI Songs, commercially available or which have been recorded on a computer, etc. and saved to a USB flash drive.
Internal memory	User (MIDI)	<i>U.</i>	U.01–U.10 MIDI Songs which have been recorded to internal memory of this instrument (page 29).

\* The categories for USB flash drive are shown only when a USB flash drive is connected. The categories for External Songs are shown only when relevant data exist.

### NOTE

Songs recorded by this instrument are called “User” Songs, while Songs created in other ways or on other devices are called “External” Songs. When you record a Song to a USB flash drive, a “USER FILES” folder is created automatically, and the resulting User Song is saved in this folder. Songs in the “USER FILES” folder are handled as User Songs while Songs in a location other than the “USER FILES” folder are handled as External Songs. For information about the playback sequence of Songs in the USB flash drive, refer to page 26.



- 1** (Only when playing a Song from a USB flash drive)  
**Connect the USB flash drive to the [USB TO DEVICE] terminal.**  
 Before using the USB flash drive, be sure to read “Connecting USB devices” on page 55.

- 2** Press the Menu button several times until the [SONG] lamp lights up in orange.

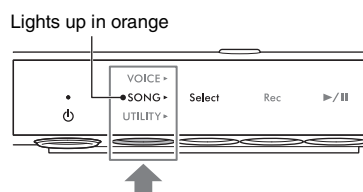

- 3** Press Button 1 [Select] several times to select the Song category (page 24).

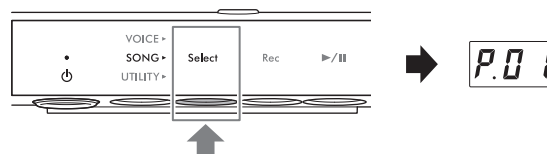

- 4** Rotate the [VALUE] control to select the desired Song.

When one of the following displays is called up, all Songs in the category play back in turn continuously until you stop playback. When you call up any other Song numbers, only the selected Song plays back.

- \*.rd (Random Playback): Continuously plays back all Songs in the selected category in random order.
- \*.AL (All-repeat Playback): Continuously plays back all Songs in the selected category in number order.

The asterisk (\*) indicates one of the Song categories. For example, selecting “P.rd” plays all preset Songs in random order.

#### NOTE

- Pressing the [VALUE] control selects the first Song in the selected Song category.
- Continuous playback is not available for Voice Demo Songs.

- 5** Press Button 3 [▶/||] (Play/Pause) to start playback.

The [▶/||] (Play/Pause) lamp lights up and the current position (measure number or elapsed time) appears in the display. The dot at the lower right of the display flashes at the MIDI Song tempo (or the metronome tempo when playing back an Audio Song). For information on playback-related operations, see page 27.

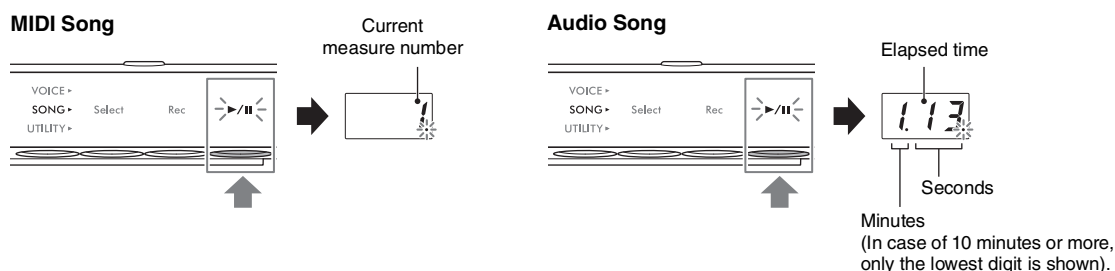

#### NOTE

The current position is not displayed when playing back Voice Demo Songs.

Usually, the Song stops automatically when playback of the selected Song reaches the end. To stop manually during playback, press Button 1 [Select].

## Playback sequence of Songs in a USB flash drive

The Songs stored in the USB flash drive are sorted and played back in the order below.

User Songs are named as follows, and are saved in the “USER FILES” folder. Songs are played back in ascending order of the Song number (\*\*).

- USERSONG\*\*.MID (MIDI Song)
- USERAUDIO\*\*.WAV (Audio Song)

External Songs are played back first in numeric order, and then from successive folders in alphabetical order. The Root folder has priority over the general folders.

USB flash drive

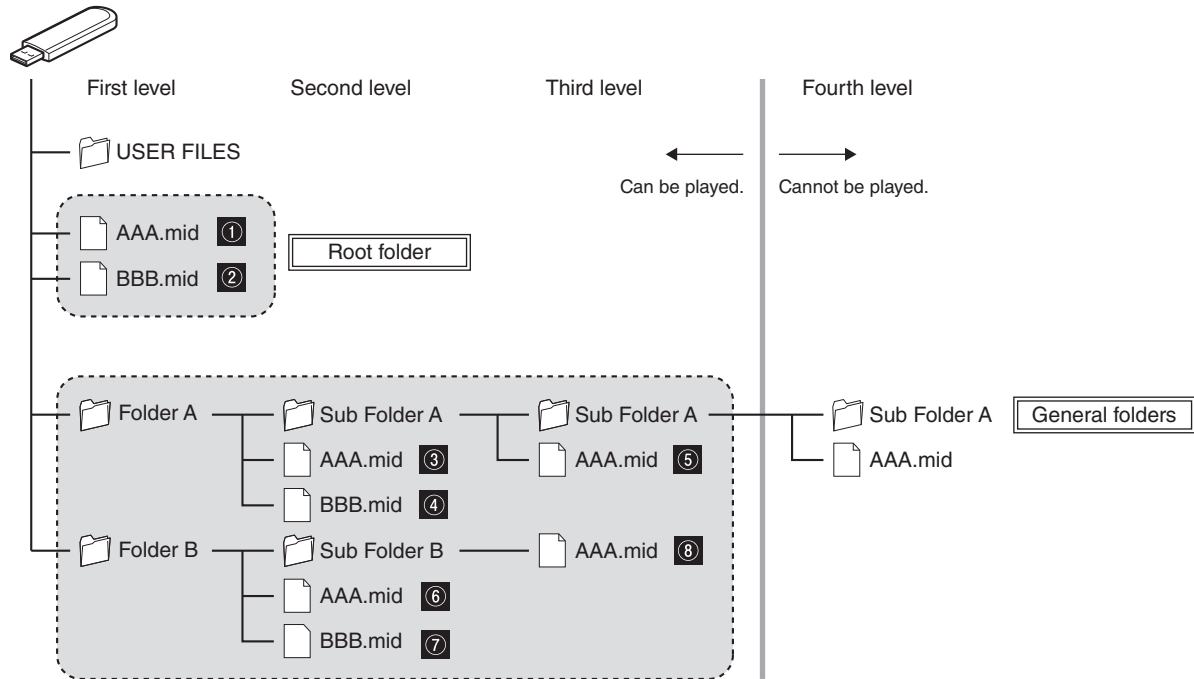

### NOTE

This instrument cannot recognize Song files saved in a folder lower than the third level. If you manage Song files in a USB flash drive with a computer, make sure to save them to the first, second or third level folder.

## Playback operations

Playback continues even when you change the menu (VOICE/SONG/UTILITY) while a Song is playing. Only when SONG is selected, the following operations are available during playback.

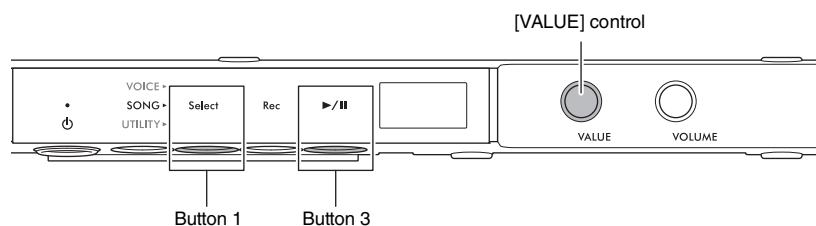

### • Pause

Press Button 3 [▶/||] (Play/Pause) to pause playback. The playback position shown in the display also pauses and the [▶/||] (Play/Pause) lamp flashes. Pressing the button again resumes Song playback from the current position.

### • Stop

Press Button 1 [Select] to stop playback. When the end of the current Song is reached, playback stops automatically. When the Song is played back next time by pressing Button 3 [▶/||] (Play/Pause), it starts from the beginning.

### • Fast forward/Rewind

Rotate the [VALUE] control to the left to rewind, and to the right to fast forward. MIDI Songs are moved one measure back or forward, while Audio Songs are moved in one-second increments.

#### NOTE

Fast forward and rewind operations are not available for Voice Demo Songs.

### • Returning to the Song top

Press the [VALUE] control to jump to the top of the Song.

#### NOTE

During playback of a Voice Demo Song, this operation selects Voice Demo Song “d.01.”

### • Adjusting the playback tempo

You can change the tempo of a MIDI Song or the speed of an Audio Song during playback. It can be adjusted with the same operation as metronome tempo. For details, refer to page 39.

#### MIDI Songs:

The tempo can be adjusted from 5 to 500 beats per minutes. It can also be adjusted while the Song is paused. When the Song stops, it is reset to the default setting.



#### Audio Songs:

Compared to an original speed of 100%, tempo can be adjusted over a range of 75%–125%. The setting value is maintained until another Song is selected.

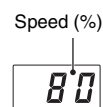

#### NOTE

- For MIDI Songs having tempo changes in the middle of the Song, changing the tempo relatively alters the entire tempo. For example, in a Song that is set to a tempo of 100 at the start and changes midway during the Song to 120, changing the starting tempo to 110 (10% faster) will result in a midway tempo of 132 (10% faster).
- When the MIDI Song tempo is changed, the metronome tempo is also changed to the same tempo. The Audio Song speed does not affect the metronome tempo.
- While an Audio Song is paused and the metronome is played back, this operation changes only the metronome tempo and the Audio Song speed does not change.

# Specifying the playback part (right-hand/left-hand) for a MIDI Song

Depending on the particular MIDI Song, such as preset Songs, the Song data may include independent right-hand and left-hand parts. This type of Song data allows you to specify the playback part, and practice the part of one hand while the other part is playing back.

## NOTE

- A MIDI Song consists of 16 channels and on each of the preset Songs, the right-hand part is assigned to channel 1 and the left is assigned to channel 2. On this instrument, only channels 1 and 2 can be independently muted; channels 3–16 are always played back.
- You cannot specify the playback part for Songs that have no data in channels 1 or 2, or for the Voice Demo Songs.

**1** Select a MIDI Song, and then start playback (steps 1–5 on page 25).

**2** Hold down Button 1 [Select] for two seconds to call up the playback part on the display.

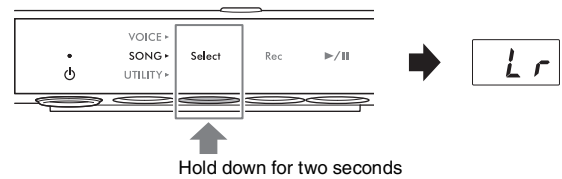

**3** Rotate the [VALUE] control to select the part to play back.

Playback continues with the selected part(s).

- **Lr**: Plays both right-hand and left-hand parts.
- **r**: Plays only the right-hand part.
- **L**: Plays only the left-hand part.

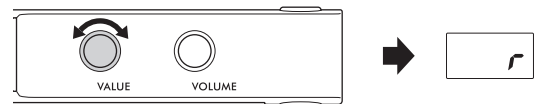

You can specify the playback part also when the Song is paused. When you stop playback, the setting is reset to “Lr.”

# Recording your performance

TA3 SH3 SC3

This instrument allows you to record your performance by using one of the following two methods.

## • MIDI recording

With this method, you can record your performance on this instrument as a MIDI Song (SMF format 0). Up to 10 MIDI Songs can be saved to internal memory and up to 100 to a USB flash drive (at 500 KB/Song max.). A MIDI Song uses a small amount of data capacity in comparison to an Audio Song. MIDI recording allows you to record each part separately.

## • Audio recording

With this method, you can record your performance on this instrument as an Audio Song (WAV). Up to 100 Audio Songs can be saved (at 80 minutes/Song max.) to a USB flash drive. The audio input sound\* from the connected external device (computer, smart device, etc.) can also be recorded.

When the Song is recorded to a USB flash drive, a MIDI Song will be named “USERSONG\*\*.MID” (\*\*: 00–99) and an Audio Song will be named “AUDIOSONG\*\*.WAV”, and saved to the “USER FILES” folder.

### NOTE

- The phrase “audio input sound” here refers to audio data sent to this instrument from external devices, such as a computer or a smart device, when connecting the instrument with such devices via [AUX IN] jack, [USB TO HOST] terminal, wireless LAN, or Bluetooth. For information on connecting to external devices, refer to Chapter 5 (page 55).
- You cannot start recording during Song playback. Make sure to stop playback beforehand.
- The acoustic piano sound cannot be recorded. When in the Layer mode (page 21), only the digital sound is recorded.
- If the Voice is set to “---”, it is recorded with the CFX Grand Voice in MIDI recording, while no sound is recorded in Audio recording.

## Basic procedure for recording (MIDI recording/Audio recording)

1

(Only when recording a Song to a USB flash drive)

**Connect a USB flash drive to the [USB TO DEVICE] terminal.**

Before using the USB flash drive, be sure to read “Connecting USB devices” on page 55.

2

**Make any necessary settings, such as Voice selection (page 22).**

3

**Press the Menu button several times until the [SONG] lamp lights up in orange.**

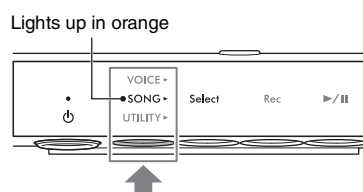

## 4 Press Button 1 [Select] several times to select the recording format (Song category).

- For MIDI recording to internal memory: U. (U.01–U.10)
- For MIDI recording to a USB flash drive: S. (S.00–S.99)
- For Audio recording to a USB flash drive: A. (A.00–A.99)

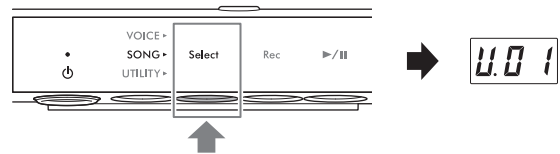

## 5 Rotate the [VALUE] control to select the Song number for recording.

You can confirm whether the selected Song contains already-recorded data by checking the display.

### NOTICE

When the selected Song number contains data, keep in mind that recording new data will overwrite the previously recorded data.

If you want to play along with the metronome sound, turn the metronome on here (page 38). The metronome sound is not recorded.

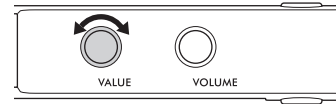

When a Song contains data:



Three dots light up.

When a Song does not contain data:



Only the left-most dot lights up.

## 6 Press Button 2 [Rec] to put recording in standby.

The [Rec] lamp lights in red, and the [▶/||] (Play/Pause) lamp flashes.

If you want to record Rhythm playback with your performance, start the Rhythm in this step (page 41). To start playback at the timing when you play the keyboard, turn on the Synchro Start function in Function F6.5 (page 51).

### NOTICE

When an “EnP” or “FUL” message appears on the display, the memory capacity of the internal memory or the USB flash drive is nearly full. We recommend that you first remove any unnecessary User Songs (page 35) to ensure sufficient memory capacity. If “EnP” appears, you can start recording, but your performance data may not be correctly saved or recording may stop automatically. If “FUL” appears, you cannot start recording.

### NOTE

To cancel recording standby status, press Button 2 [Rec] again.

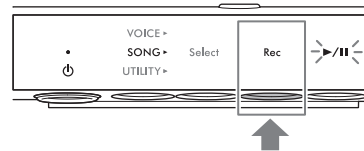

## 7 Play the keyboard to start recording.

If you want to record an empty section at the start of the Song, press Button 3 [▶/||] (Play/Pause) to start recording.

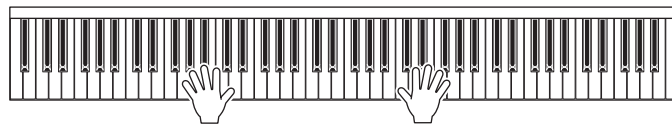

The [▶/||] (Play/Pause) lamp lights, and the current position (measure number or elapsed time) is shown on the display while recording.

### NOTICE

If “FUL” appears on the display while or after recording, this indicates the internal memory or USB flash drive capacity has become full and all or the part of the data will not be saved. We recommend that you first delete any unnecessary User Songs (page 35) to ensure sufficient memory capacity.

MIDI Song



Measure number

Audio Song

Elapsed time



Minutes  
Seconds  
(In case of 10 minutes or more, only the lowest digit is shown).

## 8 When your performance is finished, press Button 2 [Rec] or Button 3 [▶/||] (Play/Pause) to stop recording.

Dashes appear on the display in succession, indicating that the recorded data is being saved. After the data is saved, an “End” message appears, and the recorded Song number appears. Pressing Button 3 [▶/||] (Play/Pause) plays back the recorded Song.

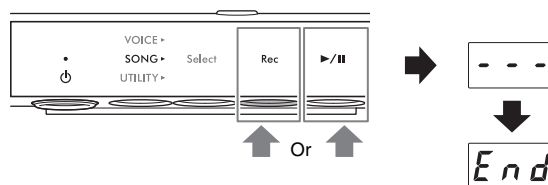

### NOTICE

While dashes appear on the display in succession, never turn off the power. Doing so may corrupt the data or damage the internal memory or USB flash drive.

## Recording the right-hand and left-hand parts independently (MIDI recording)

With MIDI recording, you can record the right-hand part and left-hand part independently. For example, you can record the right-hand part first, and then record the left-hand part while listening to the already recorded right-hand part. This allows you to create a complex Song you might not otherwise be able to play with both hands.

### 1 Record the first part. Follow the “Basic procedure for recording” (steps 1–6 on page 29) to put recording in standby.

In step 4, select the MIDI Song category (U.01–U.10 or S.00–S.99).

If you want to record a Rhythm, make sure to record it with the first part. The Rhythm part cannot be added afterwards.

### 2 Hold down Button 1 [Select] for two seconds to call up the recording part on the display.

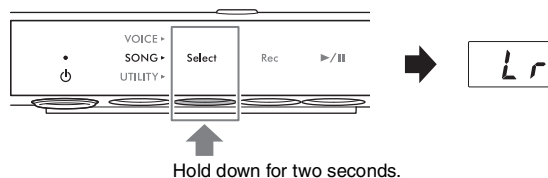

### 3 Rotate the [VALUE] control to select the part to record.

- r: For recording the right-hand part.
- L: For recording the left-hand part.

### NOTE

- Selecting “Lr” lets you record both the right- and left-hand parts (with the same operation as in “Basic procedure for recording”).
- To cancel recording standby status, press Button 2 [Rec] again.

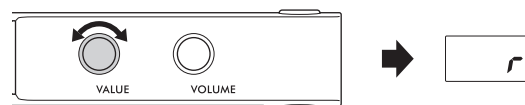

### 4 Play the keyboard to start recording.

If you want to record an empty section at the start of the Song, press Button 3 [▶/||] (Play/Pause) to start recording. The [▶/||] (Play/Pause) lamp lights, and the current measure number is shown on the display while recording.

### NOTICE

If “FUL” appears on the display while or after recording, this indicates the internal memory or USB flash drive capacity has become full and all or the part of the data will not be saved. We recommend that you first delete any unnecessary User Songs (page 35) to ensure sufficient memory capacity.

## 5 When your performance is finished, press Button 2 [Rec] or Button 3 [▶/||] (Play/Pause) to stop recording.

Dashes appear on the display in succession, indicating that the recorded data is being saved. After the data is saved, an “End” message appears, and the recorded Song number appears. Pressing Button 3 [▶/||] (Play/Pause) plays back the recorded Song.

### NOTICE

While dashes appear on the display in succession, never turn off the power. Doing so may corrupt the data or damage the internal memory or USB flash drive.

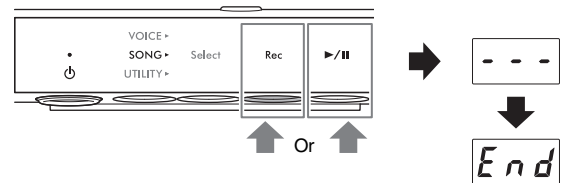

## 6 Record the second part. Press Button 2 [Rec] to put recording in standby again.

The [Rec] lamp lights in red, and the [▶/||] (Play/Pause) lamp flashes.

### NOTE

To cancel recording standby status, press Button 2 [Rec] again.

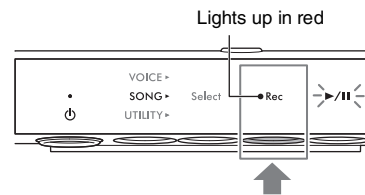

## 7 Hold down Button 1 [Select] for two seconds to call up the recording part on the display.

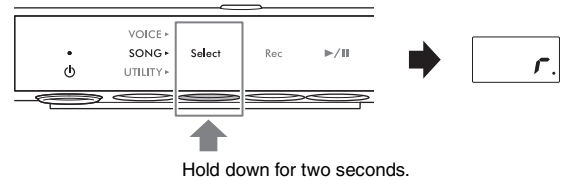

## 8 Rotate the [VALUE] control to select the part to record.

If the selected part contains already-recorded data, a dot lights up at the right side of “L” or “r” on the display.

### NOTICE

When the selected part contains data, keep in mind that recording new data will overwrite the previously recorded data.

### NOTE

To cancel recording, press Button 2 [Rec].

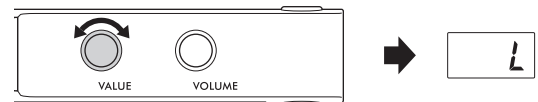

When the part contains data:

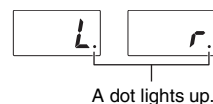

## 9 Play the keyboard to start recording.

If you want to start playback of the recorded part previously, press Button 3 [▶/||] (Play/Pause) to start recording. The [▶/||] (Play/Pause) lamp lights, and the current measure number is shown on the display while recording.

### NOTICE

If “FUL” appears on the display while or after recording, this indicates the internal memory or USB flash drive capacity has become full and all or the part of the data will not be saved. We recommend that you first delete any unnecessary User Songs (page 35) to ensure sufficient memory capacity.



# 10

When your performance is finished, press **Button 2 [Rec]** or **Button 3 [▶/||]** (Play/Pause) to stop recording.

Dashes appear on the display in succession, indicating that the recorded data is being saved. After the data is saved, an “End” message appears, and the recorded Song number appears. Pressing Button 3 [▶/||] (Play/Pause) plays back the recorded Song.

**NOTICE**

While dashes appear on the display in succession, never turn off the power. Doing so may corrupt the data or damage the internal memory or USB flash drive.

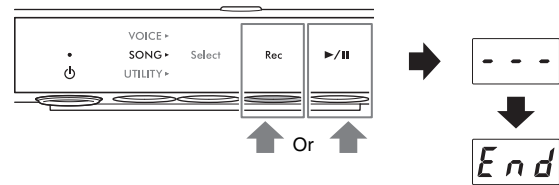

# Handling User Song files

TA3 SH3 SC3

You can copy a User Song saved in the internal memory to a USB flash drive. Also, you can delete User Songs from internal memory or a USB flash drive. Before using a USB flash drive, be sure to read “Connecting USB devices” on page 55.

## NOTE

While a Song is being recorded, played back or paused, these operations cannot be started. Make sure to stop the Song beforehand.

## Copying User Songs in internal memory to a USB flash drive

You can copy the User Song in internal memory to the connected USB flash drive. We recommend to copy your important Song data to a USB flash drive. The copied Song is saved as SMF format 0 to the “USER FILES” folder in the USB flash drive, and the file is automatically named as “USERSONG\*\*.MID” (\*\*: numerals).

## NOTE

Voice Demo Songs and preset Songs cannot be copied.

**1** Connect a USB flash drive to the [USB TO DEVICE] terminal.

**2** Press the Menu button several times until the [SONG] lamp lights up in orange.

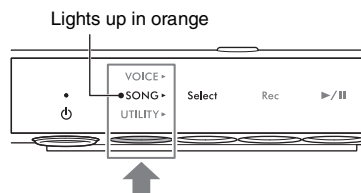

**3** Press Button 1 [Select] to select the Song category “U.” (User Song).

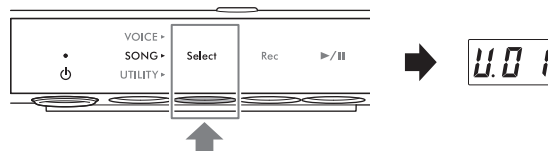

**4** Rotate the [VALUE] control to select the Song number (U.01–U.10) to copy.

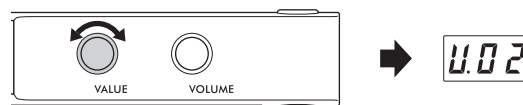

**5** Press the Menu button several times until the [UTILITY] lamp lights up in orange.

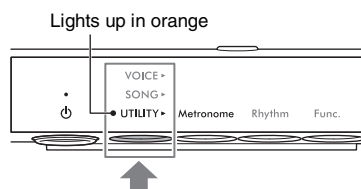

- 6** Press Button 3 [Func.] to call up the Function number in the display.

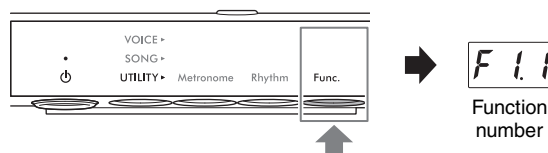

- 7** Rotate the [VALUE] control to select “F5.4” (Copying User Songs).

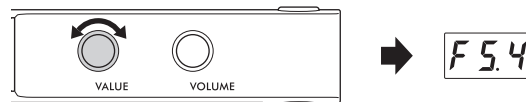

- 8** Press Button 3 [Func.] to call up “SAv” in the display.

The lowest MIDI Song number which has no data in the USB flash drive is automatically selected as the copy destination and the number is shown in the display.

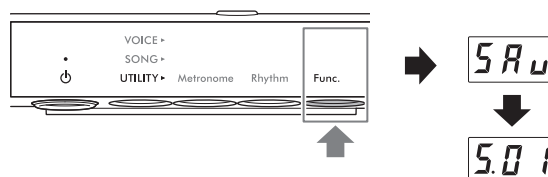

**NOTE**

- To cancel the copying operation, press any button other than Button 3 while the Song number is shown.
- If there is no empty MIDI Song number in the USB flash drive, “FUL” appears on the display and the copying operation cannot be completed. Delete any unnecessary User Songs (see below), and then execute the copy operation again.

- 9** Press Button 3 [Func.] again to start copying.

Dashes appear in succession on the display, indicating that the copy operation is in progress. When the operation is completed, “End” appears on the display.

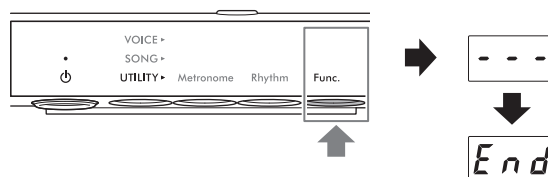

**NOTICE**

While dashes appear on the display in succession, never turn off the power. Doing so may corrupt the data or damage the internal memory or USB flash drive.

## Deleting User Songs

You can delete User Songs saved in the internal memory or the USB flash drive.

**NOTE**

Songs other than User Songs cannot be deleted.

- 1** (Only when deleting Songs in a USB flash drive)  
Connect a USB flash drive to the [USB TO DEVICE] terminal.

- 2** Press the Menu button several times until the [SONG] lamp lights up in orange.

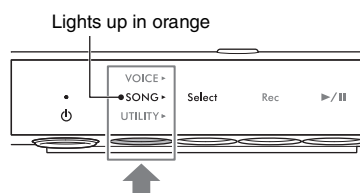

**3** Press Button 1 [Select] to select the category of the Song to be deleted.

- U. (U.01–U.10): User Songs in internal memory (MIDI)
- S. (S.00–S.99): User Songs in a USB flash drive (MIDI)
- A. (A.00–A.99): User Songs in a USB flash drive (Audio)

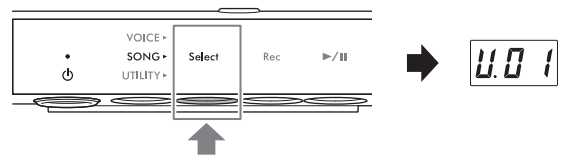

**4** Rotate the [VALUE] control to select the Song number to delete.

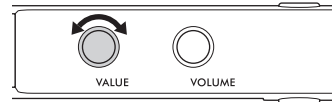

**5** Press the Menu button several times until the [UTILITY] lamp lights up in orange.

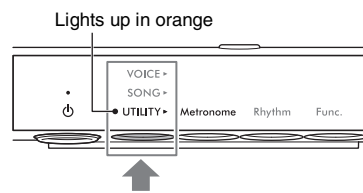

**6** Press Button 3 [Func.] to call up the Function number in the display.

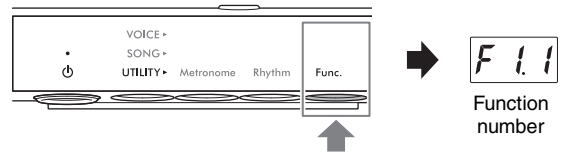

**7** Rotate the [VALUE] control to select “F5.5” (Deleting User Songs).



**8** Press Button 3 [Func.] to call up “dEL” in the display.

Following that, “n y” appears on the display.

**NOTE**

To cancel the delete operation, press any button other than Button 3 [Func.] while “n y” is shown.

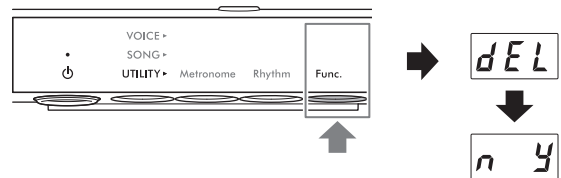

**9** Press Button 3 [Func.] again to start deleting.

Dashes appears in succession on the display, indicating that the delete operation is in progress. When the operation is completed, “End” appears on the display.

**NOTICE**

While dashes appear on the display in succession, never turn off the power. Doing so may corrupt the data or damage the internal memory or USB flash drive.

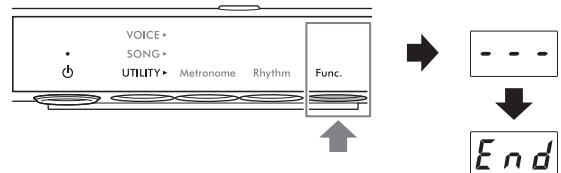

## Setting the appropriate Character Code for Song file names

TA3 SH3 SC3

If the Song in the connected USB flash drive cannot be called up, you may need to select the Character Code which is compatible with the file/folder name, from the following two settings. The default setting is “Int.”

- **Int (International)**: For playing back Songs with names using western European characters (including umlaut or diacritic marks).
- **JA (Japanese)**: For playing back Songs with names using Japanese characters and alphabets (excluding umlaut or diacritic marks).

### • To set to “JA”

While holding down the Menu button and Button 2, turn on the power by pressing the [⏻] (Standby/On) switch. “JA” appears on the display.

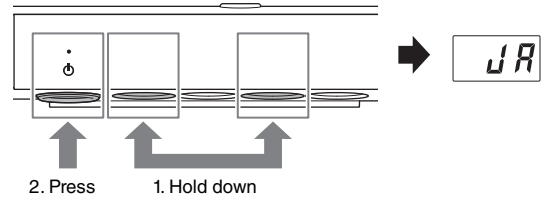

### • To set to “Int”

While holding down Button 2, turn on the power by pressing the [⏻] (Standby/On) switch. “Int” appears on the display.

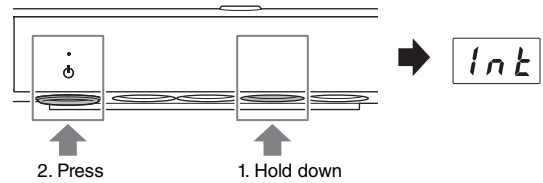

### NOTE

This setting is maintained even when the power is turned off.

The Utility operations described here allow you to use the metronome, play Rhythms and make other important and convenient settings for the instrument.

## Using the metronome

TA3 SH3 SC3

By using the metronome, you can practice with an accurate tempo, and confirm the actual tempo by hearing it.

### NOTE

(TA3 only) When in the Layer mode (page 21), you can play along with the metronome using only the acoustic piano sound by setting the Voice to “---” (page 22).

## Turning the metronome on/off

- 1 Press the Menu button several times until the [UTILITY] lamp lights up in orange.

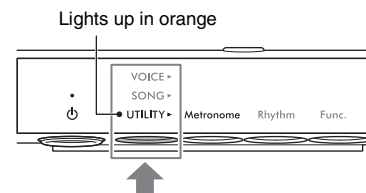

- 2 If the [Metronome] lamp is not lit in orange, press Button 1.

The current tempo appears on the display.

### NOTE

If the [Metronome] lamp is already lit in orange, pressing Button 1 here starts metronome.

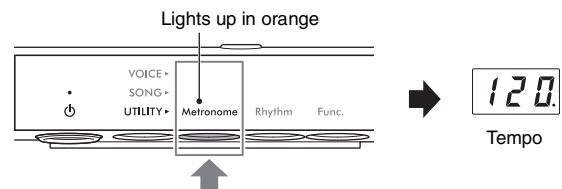

- 3 Press Button 1 [Metronome] to turn on the metronome.

While the metronome sounds, a dot at the lower right of the display flashes at the current tempo. Even when you change the menu (VOICE/SONG/UTILITY), the dot keeps flashing while the metronome is playing.

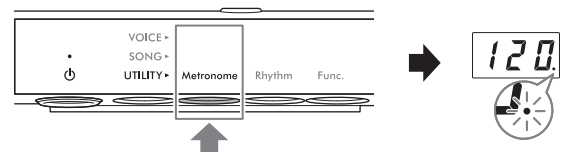

- 4 To stop the metronome, press Button 1 [Metronome] while the [Metronome] lamp is lit in orange.

## Adjusting the tempo

The metronome tempo can be set from 5 to 500 beats per minute. During Song playback (page 27), you can adjust the tempo of a MIDI Song or the speed of an Audio Song by using the operation described below.

### NOTE

- When a MIDI Song is being played back, the metronome plays back at the tempo and beat of the Song.
- When an Audio Song is being played back, this operation changes only the playback speed of the Song. The metronome tempo does not change.

**1** Press Button 1 [Metronome] in the UTILITY to call up the current tempo on the display.

**2** Rotate the [VALUE] control to adjust the tempo.

Pressing the [VALUE] control restores the default setting (120).

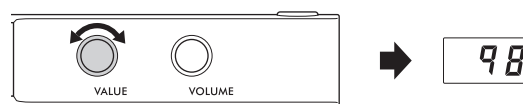

## Selecting the time signature (beat)

**1** Press Button 1 [Metronome] in the UTILITY so that the lamp lights up in orange.

**2** Hold down Button 1 [Metronome] for three seconds to call up the beat setting value on the display.

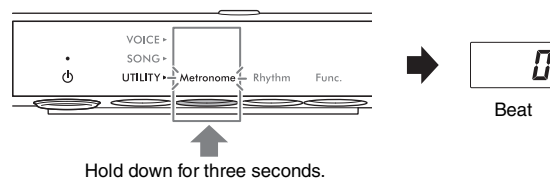

**3** Rotate the [VALUE] control to select the beat.

The beat can be selected from 0 and 2–6. For values other than 0, the first beat is accented with a bell sound to signal the start of a measure. Pressing the [VALUE] control restores the default setting (0; no 1st beat accent). Pressing Button 1 [Metronome] displays the tempo value.

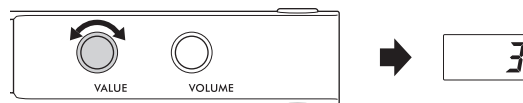

### NOTE

One beat is equal to a quarter note on this instrument. When playing a song written in non-quarter-note units, change the setting accordingly (for example, when playing a song in 3/2 time, set Beat to 6).

## Adjusting the metronome volume

### NOTE

Changing the metronome volume also changes the Rhythm volume (page 43). The volume also can be set in Function F6.1 (page 50).

**1** Press Button 1 [Metronome] in the UTILITY so that the lamp lights up in orange.

**2** While holding down Button 1 [Metronome], rotate the [VALUE] control to adjust the metronome volume.

The volume can be adjusted over a range of 1–20. Pressing the [VALUE] control restores the default setting (15).

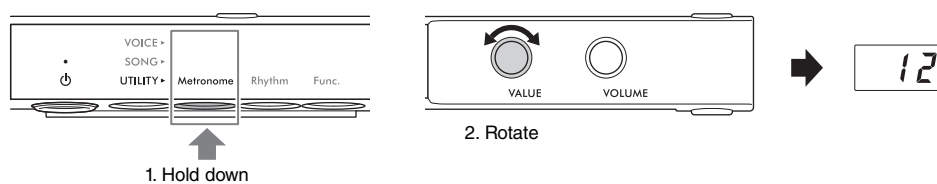



# Playing the piano along with Rhythm playback

TA3 SH3 SC3

This instrument features rhythm patterns (combinations of drums and bass accompaniment) in various music genres, allowing you to play and perform along with dynamic Rhythm playback. For information on the available Rhythms, refer to the “Rhythm List” on page 42.

## Playing back a Rhythm

**1** Press the Menu button several times until the [UTILITY] lamp lights up in orange.

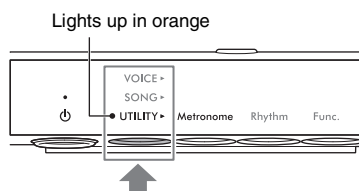

**2** If the [Rhythm] lamp is not lit in orange, press Button 2. The currently selected Rhythm number appears on the display.

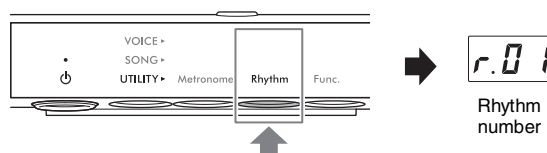

**NOTE**

If the [Rhythm] lamp is already lit in orange, pressing Button 2 here starts Rhythm playback. To stop playback, press Button 2 [Rhythm] again..

**3** Rotate the [VALUE] control to select the desired Rhythm.

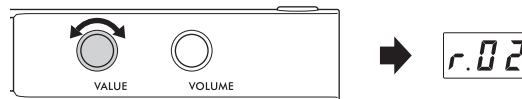

**NOTE**

The Rhythm cannot be changed while playing or recording a Song.

**4** Press Button 2 [Rhythm] to start Rhythm playback.

During Rhythm playback, a dot at the lower right of the display flashes at the current tempo. Even when you change the menu (VOICE/SONG/UTILITY), the dot keeps flashing while the Rhythm is playing.

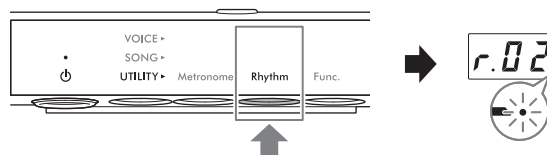

**NOTE**

- Intro and Ending sections are played back at the beginning and ending of the Rhythm playback to vary the arrangement of the accompaniment. You can turn each of them on or off in Function F6.2 or F6.3 (page 50).
- When Synchro Start is set to on, the [Rhythm] lamp flashes, indicating Rhythm playback is in standby. Pressing any of the keys starts Rhythm playback. The Synchro Start function can be turned on/off in Function F6.5 (page 51).

## 5 Play the keyboard along with Rhythm playback.

The instrument will automatically create appropriate accompaniment bass patterns while you play, based on the chords you play. If you do not want to have the bass accompaniment sound, you can turn it off (or on, as desired) in Function F6.4 (page 51).

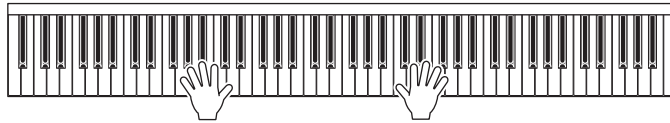

### NOTE

Some arrangements may not be suitable for use with this feature.

## 6 To stop Rhythm playback, press Button 2 [Rhythm] while the [Rhythm] lamp is lit in orange.

## Rhythm List

TA3 SH3 SC3

Display	Rhythm Name	Display	Rhythm Name
r.01	8 Beat	r.11	Swing
r.02	16 Beat	r.12	Jazz Waltz
r.03	Shuffle 1	r.13	Samba
r.04	Shuffle 2	r.14	Bossa Nova
r.05	Shuffle 3	r.15	Rumba
r.06	Gospel	r.16	Salsa
r.07	8 Beat Ballad	r.17	Kids Pop
r.08	6/8 Slow Rock	r.18	6/8 March
r.09	Fast Jazz	r.19	Christmas Swing
r.10	Slow Jazz	r.20	Christmas 3/4

# Adjusting the Rhythm volume

## NOTE

Changing the Rhythm volume also changes the metronome volume (page 40). The volume also can be set in Function F6.1 (page 50).

**1** Press Button 2 [Rhythm] in the UTILITY so that the lamp lights up in orange.

**2** While holding down Button 2 [Rhythm], rotate the [VALUE] control to adjust the metronome volume.

The volume can be adjusted over a range of 1–20. Pressing the [VALUE] control restores the default setting (15).

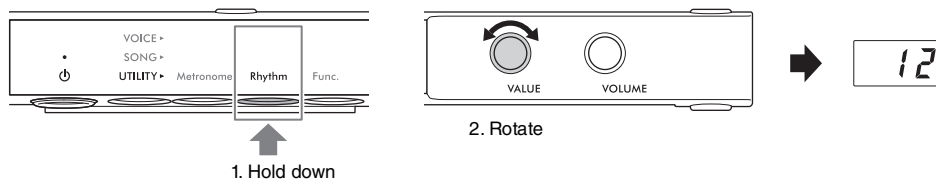

# Customizing with the various Function parameters

TA3 SH3 SC3

You can tune the instrument, adjust the metronome volume, and set a wide range of other convenient Function parameters to customize the instrument to suit your personal/performance preferences. For information on the available functions, refer to the “Function List” on page 45.

## Basic Function-setting operations

- 1 Press the Menu button several times until the [UTILITY] lamp lights up in orange.

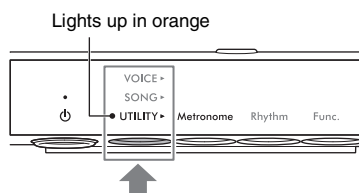

- 2 Press Button 3 [Func.] to call up the Function number in the display.

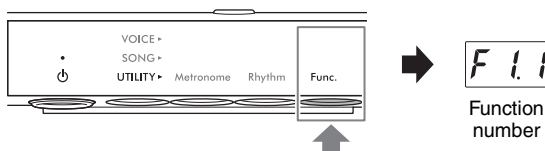

- 3 Rotate the [VALUE] control to select the desired Function number.

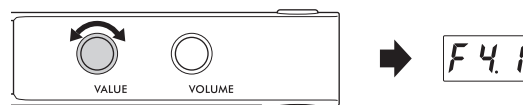

- 4 Press Button 3 [Func.] to display the parameter value.

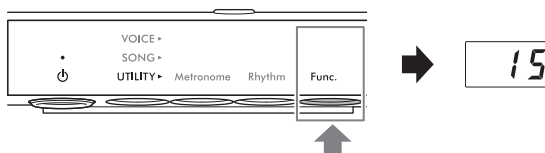

- 5 Rotate the [VALUE] control to change the parameter value.  
Pressing the [VALUE] control restores the default value. To continue to set other Functions, repeat the operation from step 2 above. To exit from the Function settings, press any button other than Button 3.

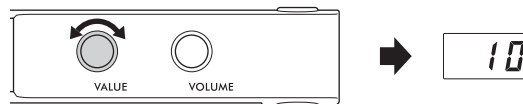

## Function List

The Functions are categorized as follows.

- **Reverb settings:** F1.1–F1.3 (see below)
- **Voice effect settings:** F2.1–F2.9 (page 46)
- **Performance settings:** F3.1–F3.6 (page 47)
- **Sound settings:** F4.1–F4.9 (page 49)
- **Song settings:** F5.1–F5.6 (page 50)
- **Metronome/Rhythm settings:** F6.1–F6.5 (page 50)
- **Overall settings:** F7.1–F8.5 (page 51)

### ■ Reverb settings

Function No.	Description		Setting range	Default setting																					
<b>F 11</b>	Reverb On/Off	<p>This function adds reverberation to the sound, including the keyboard performance and Song playback. Turning this function on and simulating the reverberation in a concert hall, etc. gives you the feeling of the being at a live performance.</p> <p><b>NOTE</b> (TA3 only) When the [TA] lamp is lit (i.e. while in the TransAcoustic mode or Layer mode), the Reverb is automatically turned off. If the [TA] lamp is lit, the Reverb on/off setting (F1.1) will not be backed up even when the Backup of Voice settings (F7.3) is set to on.</p>	On/OFF	On																					
<b>F 12</b>	Reverb Depth	Adjusts the Reverb depth. This cannot be set when the Reverb (F1.1) above is set to OFF and dashes are shown in the display.	1–20	Differs depending on the Voice																					
<b>F 13</b>	Reverb Type	<p>Selects a Reverb type. This cannot be set when the Reverb (F1.1) above is set to OFF and dashes are shown in the display.</p> <p><b>NOTE</b> When an external Song (page 24) is played back, or when the MIDI data is received (from a computer or MIDI device; pages 63, 64), dashes may appear on the display. This indicates that the data uses a Reverb type which is not available on this instrument.</p> <table border="1"> <tbody> <tr> <td><b>OFF</b></td> <td>Off</td> <td>No effect is applied.</td> </tr> <tr> <td><b>r.HL</b></td> <td>Recital Hall</td> <td>Simulates clear reverberation in a mid-sized hall suitable for piano recital.</td> </tr> <tr> <td><b>c.HL</b></td> <td>Concert Hall</td> <td>Simulates brilliant reverberation in a large hall for public orchestra performances.</td> </tr> <tr> <td><b>Chn</b></td> <td>Chamber</td> <td>Simulates the elegant reverberation in a small room suitable for chamber music.</td> </tr> <tr> <td><b>Cat</b></td> <td>Cathedral</td> <td>Simulates the solemn reverberation in a high-ceiling stone-made cathedral.</td> </tr> <tr> <td><b>CLb</b></td> <td>Club</td> <td>Simulates the lively reverberation in a jazz club or a small bar.</td> </tr> <tr> <td><b>PLt</b></td> <td>Plate</td> <td>Simulates the bright sound of vintage reverb equipment used in recording studios.</td> </tr> </tbody> </table>	<b>OFF</b>	Off	No effect is applied.	<b>r.HL</b>	Recital Hall	Simulates clear reverberation in a mid-sized hall suitable for piano recital.	<b>c.HL</b>	Concert Hall	Simulates brilliant reverberation in a large hall for public orchestra performances.	<b>Chn</b>	Chamber	Simulates the elegant reverberation in a small room suitable for chamber music.	<b>Cat</b>	Cathedral	Simulates the solemn reverberation in a high-ceiling stone-made cathedral.	<b>CLb</b>	Club	Simulates the lively reverberation in a jazz club or a small bar.	<b>PLt</b>	Plate	Simulates the bright sound of vintage reverb equipment used in recording studios.	(See the column at left)	Differs depending on the Voice
<b>OFF</b>	Off	No effect is applied.																							
<b>r.HL</b>	Recital Hall	Simulates clear reverberation in a mid-sized hall suitable for piano recital.																							
<b>c.HL</b>	Concert Hall	Simulates brilliant reverberation in a large hall for public orchestra performances.																							
<b>Chn</b>	Chamber	Simulates the elegant reverberation in a small room suitable for chamber music.																							
<b>Cat</b>	Cathedral	Simulates the solemn reverberation in a high-ceiling stone-made cathedral.																							
<b>CLb</b>	Club	Simulates the lively reverberation in a jazz club or a small bar.																							
<b>PLt</b>	Plate	Simulates the bright sound of vintage reverb equipment used in recording studios.																							

## ■ Voice effect settings

The terms marked with an asterisk (\*) are explained in the “Glossary of terms” on page 53.

### NOTE



On the TA3, the effects F2.1–F2.6 are effective only when headphones are connected.

Function No.	Description		Setting range	Default setting
<b>F2.1</b>	VRM On/Off	Turns the VRM (Virtual Resonance Modeling) effect* on/off. When set to on, the VRM effect is applied only to piano Voices (PF.1–PF.5). Damper Resonance, Damper Noise, String Resonance, Duplex Scale Resonance and Body Resonance produced by VRM can be adjusted separately in F2.2–F2.6.	On/OFF	On
<b>F2.2</b>	Damper Resonance	Determines the depth of the resonance effect produced by VRM which is applied when the damper pedal is pressed. This parameter is effective only when VRM (F2.1) is on and one of the piano Voices (PF.1–PF.5) is selected.	0–10	5
<b>F2.3</b>	Damper Noise	Turns the Damper Noise* produced by the VRM effect on/off. This parameter is effective only when VRM (F2.1) is on and one of the piano Voices (PF.1–PF.5) is selected. When the Damper Resonance (F2.2) is set to 0, this effect will be disabled.	On/OFF	On
<b>F2.4</b>	String Resonance	Determines the depth of the string resonance effect produced by VRM which is applied when a note on the keyboard is pressed. This parameter is effective only when VRM (F2.1) is on and one of the piano Voices (PF.1–PF.5) is selected.	0–10	5
<b>F2.5</b>	Duplex Scale Resonance	Adjusts the sympathetic vibrations of the duplex scaling* resonance effect in VRM. This parameter is effective only when VRM (F2.1) is set to on and one of the piano Voices (PF.1–PF.5) is selected.	0–10	5
<b>F2.6</b>	Body Resonance	Determines the depth of the Body resonance effect which simulates the resonance of the piano itself—i.e., the soundboard, the sides, the frame and so on. This parameter is effective only when VRM (F2.1) is on and one of the piano Voices (PF.1–PF.5) is selected.	0–10	5
<b>F2.7</b>	Grand Expression Modeling	Selects the type of the Grand Expression Modeling* effect. When this feature is set to “Dynamic,” you can control extremely subtle nuances in the performance and sound by changing your playing strength or touch. When set to “Static,” the nuances are generally fixed. Grand Expression Modeling is effective only for the Voices of “CFX Grand” and “Bösendorfer.”	dYn (Dynamic)/ Stc (Static)	dYn (Dynamic)
<b>F2.8</b>	Pan	Adjusts the stereo pan position for the Voice played on the keyboard.	L64 (leftmost)–C (center)–r63 (rightmost)	Differs depending on the Voice

Function No.	Description		Setting range	Default setting
<b>F29</b>	Keyboard Transpose	<p>Shifts the pitch of the entire keyboard up or down in semitone intervals to facilitate playing in difficult key signatures, and to let you easily match the pitch of the keyboard to the range of a singer or other instruments. For example, if you set this parameter to “5,” playing key C produces pitch F. In this way, you can play the F major song as if it were in C major.</p> <p><b>NOTE</b> Your keyboard performance data will be transmitted with the transposed note numbers while MIDI note numbers received from an external MIDI device or computer will not be affected by the transpose setting here.</p>	-12-0+12	0

## ■ Performance settings

Function No.	Description		Setting range	Default setting	
<b>F31</b>	Half Pedal Point	The Half-pedal function allows you to use half-damper techniques, in which the damper is pressed somewhere between all the way down and all the way up. In this half-damper state (on a real piano), the damper felts only partially mute the strings. This parameter determines the point to which you must depress the right pedal to apply the half-pedal effect. The larger the value, the deeper you need to press the pedal for the half-pedal effect.	-2-0+4	0	
<b>F32</b>	Touch Sensitivity	Determines how the sound responds to your playing strength.	(See the column at left)	0 (Medium)	
		-2 (Soft)			Produces relatively high volume even with light playing strength.
		-1 (Soft/Medium)			Produces high volume with moderate playing strength.
		0 (Medium)			Standard Touch Sensitivity
		1 (Medium/Hard)			Requires moderately strong playing for high volume.
		2 (Hard)			Requires strong playing to produce high volume.
	OFF (Fixed)	The volume level will be the same regardless of your playing strength. The velocity (or volume) can be set in F3.3.			
<b>F33</b>	Fixed Velocity	Determines the velocity with which the sound responds when Touch Sensitivity is set to “OFF” (Fixed).	1-127	64	
<b>F34</b>	Master Tune	<p>Fine-tunes the pitch of the entire instrument in 0.2 Hz steps. This lets you accurately match the keyboard pitch to that of other instruments or music on a music player, etc.</p> <p><b>NOTE</b> The hundreds digit is omitted for the value shown in the display (e.g., “40.2” stands for 440.2 Hz).</p>	414.8-466.8 (Hz)	440.0 (Hz)	

Function No.	Description		Setting range	Default setting	
<b>F35</b>	Scale Type (Temperament)	Modern acoustic pianos are tuned almost exclusively in equal temperaments. Likewise, this instrument employs equal temperament, but you can select one of various scales for playing in custom tunings for specific historical periods or music genres.	(See the column at left)	1 (Equal)	
		1 (Equal)			The pitch range of each octave is divided equally into twelve parts, with each half-step evenly spaced in pitch. This is the most commonly used tuning in music today.
		2 (Pure Major)			These tunings preserve the pure mathematical intervals of each scale, especially for triad chords (root, third, fifth). You can hear this best in actual vocal harmonies—such as choirs and a cappella singing.
		3 (Pure Minor)			
		4 (Pythagorean)			This scale was devised by the famous Greek philosopher and is created from a series of perfect fifths, which are collapsed into a single octave. The 3rd in this tuning are slightly unstable, but the 4th and 5th are beautiful and suitable for some leads.
		5 (Mean-Tone)			This scale was created as an improvement on the Pythagorean scale, by making the major third interval more “in tune.” It was especially popular from the 16th century to the 18th century. Handel, among others, used this scale.
		6 (Werckmeister)			This composite scale combines the Werckmeister and Kirnberger systems, which were themselves improvements on the mean-tone and Pythagorean scales. The main feature of this scale is that each key has its own unique character. The scale was used extensively during the time of Bach and Beethoven, and even now it is often used when performing period music on the harpsichord.
7 (Kirnberger)					
<b>F36</b>	Base Note	When the Scale above is set to something other than “Equal Temperament,” you need to set the base note for the selected Scale. When the base note is changed, the pitch of the keyboard is transposed, yet maintains the original pitch relationship between the notes.	C, C#, D, Eb, E, F, F#, G, Ab, A, Bb, B	C	
		 C#  Eb			
		In the display, the note is followed by a high bar if sharp, and the note is followed by a low bar if flat.			



## ■ Sound settings

Function No.	Description		Setting range	Default setting
F41	Binaural On/Off	Turns the Binaural (or Stereophonic Optimizer) function (page 19) on or off. When this function is on and a piano Voice (PF1–PF5) is selected, the sound from this instrument changes to the sound of Binaural Sampling or the sound enhanced with the Stereophonic Optimizer, allowing you to enjoy more realistic sound even when listening with headphones. <b>NOTE</b> This is effective only when headphones are connected.	On/OFF	On
F42	Brilliance	Adjusts the timbre brilliance of the entire keyboard sound from mellow to bright.	–2 (Mellow) –0 (Normal) +2 (Bright)	0 (Normal)
F43	IAC On/Off	IAC is a function which automatically adjusts and controls the sound quality according to the volume of the instrument. Even when the volume is low, it permits both low sounds and high sounds to be clearly heard.	On/OFF	On
F44	IAC Depth	Determines the depth of the IAC. The higher the value, the more clearly the low/high frequencies sound at lower volume levels.	–3–0–+3	0
F45	Audio EQ TA3 SH3 SC3	Determines whether the optimum EQ (or Equalizer) settings are applied for audio input sound from the external device (such as a computer or a smart device) or not. When this function is set to on, audio input sound from the external device will be optimized to be played on this instrument. We recommend that you turn this function off when outputting audio input to an external device along with the performance played on the instrument. <b>NOTE</b> The phrase “audio input sound” here refers to audio data sent to this instrument from external devices, such as a computer or a smart device, when connecting the instrument with devices via [AUX IN] jack, [USB TO HOST] terminal, wireless LAN, or Bluetooth. For information on connecting to external devices, refer to Chapter 5 (page 55).	On/OFF	On
F46	TransAcoustic Resonance Adjustment TA3 SH3 SC3	Optimizes the resonance so that it sounds natural even when the lid is closed (or open), while playing in the TransAcoustic mode or Layer mode. Set it to “OPn” when the lid is open, and to “CLS” when the lid is closed.	OPn (Open)/ CLS (Close)	Upright pianos: CLS, Grand pianos: OPn
F47	TransAcoustic Tone Control TA3 SH3 SC3	Adjusts the tone of sounds from the soundboard in the low (F4.7), mid (F4.8) or high (F4.9) frequency ranges, while playing in the TransAcoustic mode or Layer mode.	–12–0–+12	0
F48				
F49				

## ■ Song settings

Function No.	Description		Setting range	Default setting
<b>F5.1</b>	MIDI Song/ Keyboard Volume Balance	Adjusts the volume balance between the keyboard performance and MIDI Song playback. The higher the value, the lower the Song playback volume becomes; the lower the value, the lower the keyboard performance volume becomes. To adjust the balance with Audio Song, adjust the Audio Song volume in F5.3.  <b>NOTE</b> Some PianoSoft Songs have their own volume balance settings. These settings take priority to the balance setting here.	-64-0-+64	0
<b>F5.2</b>	Song Transpose	Shifts the pitch of the MIDI Song or Audio Song up or down in semitone intervals. For example, if you set this parameter to "5," the pitch of key C is played back as F. In this way, an F major song is played back as if it were in C major.  <b>NOTE</b> • MIDI note numbers received from an external MIDI device or computer will not be affected by the transpose setting here. • Applying transpose to an Audio Song may change its tonal characteristics.	-12-0-+12	0
<b>F5.3</b>	Audio Song Volume	Adjusts the volume of Audio Song playback.	1-20	16
<b>F5.4</b>	Copying User Songs	Copies the User Songs saved in the internal memory to the connected USB flash drive. For details, refer to page 34.	—	—
<b>F5.5</b>	Deleting User Songs	Deletes the User Songs in the internal memory or the connected USB flash drive. For details, refer to page 35.	—	—
<b>F5.6</b>	Formatting a USB flash drive	Formats or initializes the USB flash drive. For details, refer to page 56.  <b>NOTICE</b> <b>Executing the Format operation will delete all data saved in the USB flash drive. Save important data to a computer or another storage device.</b>	—	—

## ■ Metronome/Rhythm settings

Function No.	Description		Setting range	Default setting
<b>F6.1</b>	Metronome/ Rhythm Volume	Adjusts the volume of both the metronome and Rhythm.	1-20	15
<b>F6.2</b>	Rhythm Intro	Determines whether the Intro is played back (On) or not (OFF) before the Rhythm pattern is started.  <b>NOTE</b> During Song playback, the Intro cannot be played back even if you start the Rhythm with this parameter set to "On."	On/OFF	On
<b>F6.3</b>	Rhythm Ending	Determines whether the Ending is played back (On) or not (OFF) before the Rhythm pattern is stopped.	On/OFF	On

Function No.	Description		Setting range	Default setting
<b>F64</b>	Rhythm Bass	Determines whether the auto bass accompaniment for the Rhythm is on or off.	On/OFF	On
<b>F65</b>	Rhythm Synchro Start	Determines how the Rhythm playback starts. <ul style="list-style-type: none"> <li>On: You can start Rhythm playback by pressing any key on the keyboard. Pressing Button 2 [Rhythm] in Utility (step 4 on page 41) makes the [Rhythm] lamp flash, and puts Rhythm playback in standby. In this status, pressing any key starts Rhythm playback.</li> <li>OFF: Press Button 2 [Rhythm] in the UTILITY to start Rhythm playback (step 4 on page 41).</li> </ul>	On/OFF	OFF

## ■ Overall settings

Function No.	Description		Setting range	Default setting
<b>F71</b>	MIDI Transmit Channel	Determines the MIDI channel over which the MIDI data of the keyboard performance will be transmitted to external MIDI devices. When this parameter is set to "OFF," MIDI data is not transmitted.	1–16, OFF	1
<b>F72</b>	Local Control	Determines whether the sound played on the keyboard is produced from the tone generator of this instrument or not. <ul style="list-style-type: none"> <li>On: The keyboard performance data is transmitted to the internal tone generator of this instrument and it produces the sound.</li> <li>OFF: The keyboard performance data is not transmitted to the internal tone generator of this instrument. This means that even if you play the keyboard, this instrument will produce no sound. Instead, the keyboard data can be transmitted via MIDI to a connected external MIDI device, which can produce the sound.</li> </ul>	On/OFF	On
<b>F73</b>	Backup (Voice)	Determines whether the following Voice-related settings are backed up (maintained even if the power is turned off) or not. To back up the settings, set this parameter to On. <ul style="list-style-type: none"> <li>Current Voice</li> <li>Reverb settings (F1.1–F1.3)</li> <li>Voice effect settings (F2.1–F2.8)</li> </ul>	On/OFF	OFF
<b>F74</b>	Backup (Others)	Determines whether the following performance-related settings are backed up (maintained even if the power is turned off) or not. To back up the settings, set this parameter to On. <ul style="list-style-type: none"> <li>Performance settings (F3.1–F3.6)</li> <li>Sound settings (F4.1–F4.7)</li> <li>Song settings (F5.1, F5.3)</li> <li>Rhythm settings (F6.1–F6.4)</li> <li>MIDI settings (F7.1–F7.2)</li> </ul>	On/OFF	On
<b>F75</b>	Bluetooth On/Off	Turns the Bluetooth function on/off. To connect with a Bluetooth-equipped device such as a smartphone, set this to On. For details, refer to page 59.  <b>NOTE</b> Depending on the country in which you purchased the product, the instrument may not have Bluetooth capability. For information on whether Bluetooth functionality is included or not, refer to page 8.	On/OFF	On

Function No.	Description		Setting range	Default setting
F76	Bluetooth Pairing	Registers the Bluetooth-equipped device on this instrument. While "F7.6" is shown in the display, press Button 3 [Func.] to put pairing in standby on the instrument. After that, make settings on the Bluetooth equipped-device. For detailed instructions, refer to page 59.	—	—
F81	Auto Power Off	<p>Enables or disables the Auto Power Off function (page 16).</p> <ul style="list-style-type: none"> <li>• On: The power is automatically turned off if the instrument is not operated for approximately 30 minutes.</li> <li>• OFF: The power will not be turned off automatically. Press the [⏻] (Standby/On) switch to turn off the power.</li> </ul> <p><b>NOTICE</b>  <b>When the instrument is communicating with other devices or the Songs are played back, the power will not be turned off automatically. Make sure to turn off the power by pressing the [⏻] (Standby/On) switch when the instrument is not in use.</b></p>	On/OFF	On
F82	AUX IN Noise Gate	The AUX IN Noise Gate function conveniently cuts unwanted noise from the sound input via the [AUX IN] jack. However, this may result in wanted sounds also being cut, such as the soft decay sound of a piano. To avoid this, set this function to OFF.	On/OFF	On
F83	Audio Loopback	<p>Determines whether audio input from the computer or smart device (via the USB Audio Interface function, page 63; or wireless LAN connection, page 62) is output to a computer or a smart device or not, along with the performance played on the instrument. To output the audio input, set Audio Loopback to On. For example, if you want to record the audio sound input as well as the sound played on the instrument to a computer or the smart device, set this to on. If you intend to record only the sound played on the instrument to a computer or smart device, set this to off.</p> <p><b>⚠ CAUTION</b>  <b>If you are using a DAW (digital audio workstation) application with this instrument, set Audio Loopback to OFF. Otherwise, a loud sound may occur, depending on the settings of the computer or the application software.</b></p> <p><b>NOTE</b></p> <ul style="list-style-type: none"> <li>• The sound cannot be output to a device connected by Bluetooth or the [AUX IN] jack.</li> <li>• The playback sound of an Audio Song on this instrument is also output to the external device when this is set to On, while the sound is not output when this is set to OFF.</li> <li>• With Audio recording on this instrument, the audio input sound from the external device is recorded when this is set to On, while the sound is not recorded when this is set to OFF.</li> </ul>	On/OFF	On
F84	Version	<p>The firmware version of this unit is shown in the display.  (Example) version 1.00</p> 	—	—

Function No.	Description		Setting range	Default setting
<b>F85</b>	Startup Mode (Only for grand pianos without silencing lever)	Determines whether the Quiet mode (Qt) is enabled or the Acoustic mode (Aco) is enabled when the power is turned on.	Qt/Aco	Qt

## Glossary of terms

Term	Description
Damper Noise	Damper noise is the sound made on an acoustic piano when the damper pedal is pressed. The damper noise changes in tone and volume depending on how quickly the damper pedal is pressed down. Pressing the damper pedal slowly will make a quieter sound when the damper heads are released from the strings. Pressing the damper pedal with force will transmit the vibrations to the strings, which adds a lower and louder sound.
Duplex Scale	Duplex scaling is a stringing method for pianos that uses extra, un-struck strings in the upper octaves to enhance the tone. These strings sympathetically vibrate with other strings in an acoustic piano, resonating with overtones, and adding richness, brilliance and complex color to the sound. Since the dampers do not touch them, they will continue sounding even after you release your hands from the keyboard.
Grand Expression Modeling	On an actual acoustic piano, subtle changes in the sound can be produced by changing your playing touch from when you press a key to when you release it. For example, when you press a key all the way to its bottom, the key hits the keybed underneath and the noise reaches the strings, changing the sound slightly. Furthermore, the tone when the damper is lowered onto strings to mute the sound is changed by how quickly you release the key. Grand Expression Modeling technology recreates these subtle changes in the sound that respond to your touch. This allows you to add accents by playing strongly or add resonance by playing softly to produce superbly expressive sound. A crisp tone can be heard when playing staccato as well as a lingering sound produced when releasing the keys slowly.
VRM (Virtual Resonance Modeling)	The VRM (Virtual Resonance Modeling) function uses sophisticated physical modeling to simulate the actual string resonance sound that occurs when the damper pedal on a real piano is pressed or keys are played and held. On an actual acoustic piano, if you press the damper pedal and play a key, not only does the string of the pressed key vibrate, it also causes other strings and the soundboard to vibrate, each influencing the rest and creating a rich and brilliant resonance that sustains and spreads. The VRM (Virtual Resonance Modeling) technology featured in this instrument reproduces the complicated interaction of both string and soundboard resonance faithfully using a virtual musical instrument (physical modeling), and makes the sound more like a real acoustic piano. Since instantaneous resonance is made at the moment according to the state of the keyboard or pedal, you can vary the sound expressively by changing the timing of your pressing the keys, and the timing and depth of your pressing the pedal.

## Initializing the instrument (Clearing the Backup data)

TA3 SH3 SC3

While holding down the highest key (C7), turn on the power by pressing the [⏻] (Standby/On) switch. “CLr” appears on the display and the Backup data (see below) will be initialized. Note that the Character Code for Song files, Bluetooth pairing information, and User Songs are not cleared.

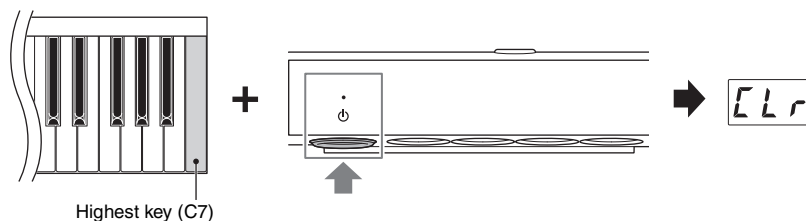

### NOTICE

While “CLr” is shown in the display, never turn off the power. Doing so may delete the User Song, or damage the internal memory.

### NOTE

If this instrument somehow becomes disabled or malfunctions, turn off the power to the instrument, and then perform the initialization procedure; this may remedy the situation.

### Backup data

The following settings, referred to as Backup data, are automatically saved to the internal memory of this instrument. The Backup data and the User Songs saved to the internal memory will be retained even if the power is turned off.

- Bluetooth on/off (Function F7.5)
- Auto Power Off setting (Function F8.1)
- Mode setting for grand pianos when the power is turned on (Function F8.5)
- Backup (Voice/Others) settings (Function F7.3–F7.4)
- Character code for Song files (page 37)
- Bluetooth pairing information (page 59)
- (Backed up only when the Function F7.3 is On) Voice settings \* See description of F7.3 for details
- (Backed up only when the Function F7.4 is On) Performance settings \* See description of F7.4 for details

## ⚠ CAUTION

Before connecting the instrument to other electronic devices, turn off the power of all the devices. Also, before turning any devices on or off, make sure to set all volume levels to minimum (0). Otherwise, damage to the devices, electrical shock, or even permanent hearing loss may occur.

## Connecting USB devices ([USB TO DEVICE] terminal)

TA3 SH3 SC3

You can connect a USB flash drive or a USB wireless LAN adaptor (sold separately) to the [USB TO DEVICE] terminal. You can save or call up the data to/from the USB flash drive (page 24), or you can connect the instrument to a smart device via wireless LAN (page 62).

### Precautions when using the [USB TO DEVICE] terminal

This instrument features a built-in [USB TO DEVICE] terminal. When connecting a USB device to the terminal, be sure to handle the USB device with care. Follow the important precautions below.

#### NOTE

For more information about the handling of USB devices, refer to the owner's manual of the USB device.

#### ■ Compatible USB devices

- USB flash drive
- USB wireless LAN adaptor UD-WL01 (sold separately; may not be available in some areas)

Other USB devices such as a USB hub, computer keyboard or mouse cannot be used.

The instrument does not necessarily support all commercially available USB devices. Yamaha cannot guarantee operation of USB devices that you purchase. Before purchasing a USB device for use with this instrument, please visit the following web page:

<https://download.yamaha.com/>

Although USB devices 2.0 or 3.0 can be used on this instrument, the amount of time for saving to or loading from the USB device may differ depending on the type of data or the status of the instrument.

#### NOTE

The rating of the [USB TO DEVICE] terminal is a maximum of 5V/500mA. Do not connect USB devices having a rating above this, since this can cause damage to the instrument itself.

#### ■ Connecting a USB device

When connecting a USB device to the [USB TO DEVICE] terminal, make sure that the connector on the device is appropriate and that it is connected in the proper direction.

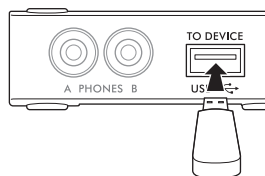

#### NOTICE

- Avoid connecting or disconnecting the USB device during playback/recording and file management operations (such as Copy, Delete and Format), or when accessing the USB device. Failure to observe this may result in “freezing” of the operation of the instrument or corruption of the USB device and the data.
- When connecting then disconnecting the USB device (and vice versa), make sure to wait a few seconds between the two operations.
- Do not use an extension cable when connecting a USB device.

### Using USB Flash Drives

By connecting a USB flash drive to the [USB TO DEVICE] terminal, you can record your performance (not including acoustic piano sound) on this instrument to the USB flash drive (page 29), as well as play back the data saved in the USB flash drive (page 24).

#### ■ Number of USB flash drives that can be used

Only one USB flash drive can be connected to the [USB TO DEVICE] terminal.

#### ■ Formatting a USB flash drive

You should format the USB flash drive only with this instrument (page 56). A USB flash drive formatted on another device may not operate properly.

#### NOTE

The format operation overwrites any previously existing data. Make sure that the USB flash drive you are formatting does not contain important data.

#### ■ To protect your data (write-protect)

To prevent important data from being inadvertently erased, apply the write-protect provided with each USB flash drive. If you are saving data to the USB flash drive, make sure to disable write-protect.

#### ■ Turning off the instrument

When turning off the instrument, make sure that the instrument is NOT accessing the USB flash drive by playback/recording or file management operations (such as during Copy, Delete and Format). Failure to do so may corrupt the USB flash drive and the data.

# Formatting a USB flash drive

TA3 SH3 SC3

When a “UnF” message appears on the display indicating that the USB flash drive has not been formatted, format the drive by the operation below.

**NOTICE**

Executing the Format operation will delete all data saved in the USB flash drive. Save important data to a computer or another storage device.

**1** Connect a USB flash drive to the [USB TO DEVICE] terminal.

**2** Press the Menu button several times until the [UTILITY] lamp lights up in orange.

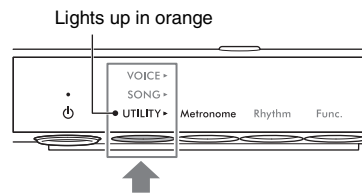

**3** Press Button 3 [Func.] to call up the Function number in the display.

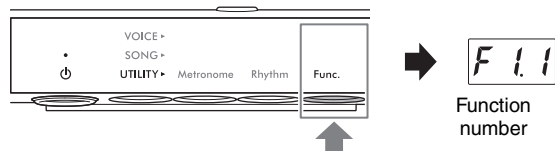

**4** Rotate the [VALUE] control to select “F5.6” (Formatting a USB flash drive).

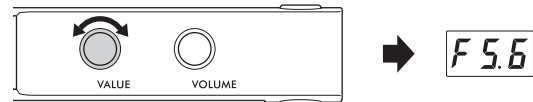

**5** Press Button 3 [Func.] to call up “For” (Format) in the display.

An “n y” message appears.

**NOTE**

While “n y” is shown in the display, you can cancel the Format operation by pressing a button other than Button 3 [Func.].

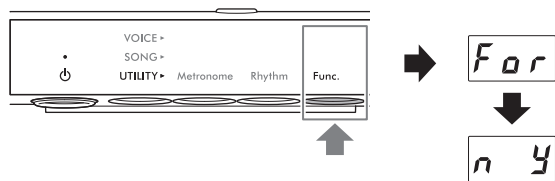

**6** When “n y” appears, press Button 3 [Func.] to execute the Format operation.

Dashes appear in succession on the display, indicating that Formatting is in progress. When the operation is completed, “End” appears on the display.

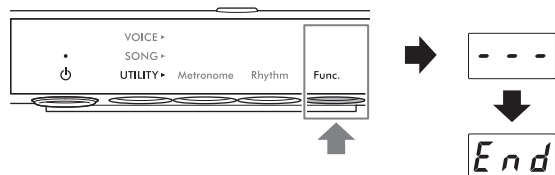

**NOTICE**

While dashes appear in succession on the display, never turn off the power or disconnect the USB flash drive. Doing so may corrupt the data on the USB flash drive, and the Format operation will not be executed properly.



# Connecting to external audio devices

## Output the digital sound of the instrument to an external device (AUX OUT jacks)

TA3 SH3 SC3

By connecting powered speakers or a stereo system to the AUX OUT [R]/[L/L+R] jacks via an audio cable, you can listen to the performances (digital sound) played on this instrument through the external speakers. Also, if you connect an audio recorder such as an IC recorder, you can record performances played on this instrument.

### NOTICE

To avoid possible damage, first turn on the power to the instrument, and then to the external device(s). When turning off the power, first turn off the power to the external device(s), and then to the instrument.

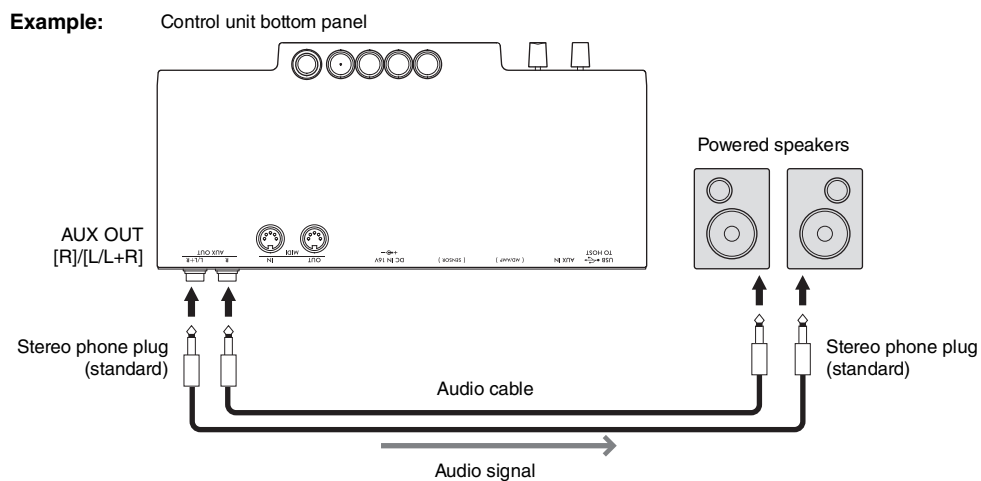

### NOTE

- You can use the [VOLUME] control on this instrument to adjust the output volume from the AUX OUT jacks.
- The acoustic piano sound is not output from the AUX OUT jacks.
- Use only the [L/L+R] jack for connection with a monaural device.
- When you are listening to the digital sound output to the external device via the AUX OUT jacks from headphones connected to this instrument, we recommend that you set the Binaural function to off. The on/off setting can be changed in Function F4.1 (page 49).

# Listening to Audio playback on an external device through this instrument ([AUX IN] jack)

TA3 SH3 SC3

By connecting an audio player such as smartphone or portable music player to the [AUX IN] jack via an audio cable, you can listen to the sound played on the connected audio player through this instrument. In the Quiet mode (page 18), the sound input to the [AUX IN] jack can be heard from the headphones, while in the TransAcoustic mode (page 20) or Layer mode (page 21), the sound is output from the soundboard.

### NOTICE

- To avoid damage to the devices, first turn on the power to the external device(s), and then to the instrument. When turning off the power, first turn off the power to the instrument, and then to the external device(s).
- Do not route the output from the AUX OUT jacks to the AUX IN jack. If you make this connection, the signal input at the [AUX IN] jack is output from the AUX OUT jacks. These connections could result in a feedback loop that will make normal performance impossible, and may even damage the equipment.

### Example:

Control unit bottom panel

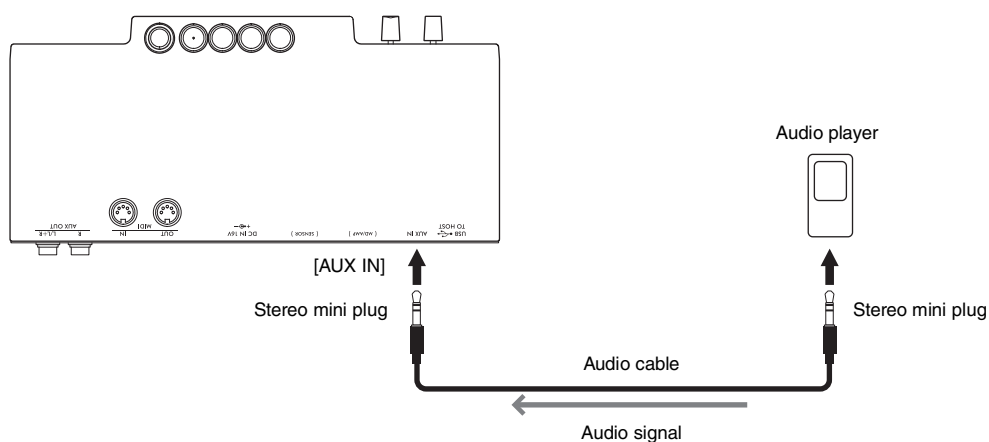

### NOTE

- Use audio cables and adaptor plugs having no (zero) resistance.
- This instrument cuts unwanted noise from the input sound via the [AUX IN] jack. However, this may result in wanted sounds also being cut, such as the soft decay sound of a piano. To avoid this, set the AUX IN Noise Gate function to off in Function F8.2 (page 52).

## Listening to audio data played by a Bluetooth-equipped device through this instrument (Bluetooth Audio function)

This Bluetooth Audio function lets you listen to the audio data played on a Bluetooth-equipped device such as a smart device (smartphone or tablet) or portable audio player through this instrument. In the Quiet mode (page 18), the sound can be heard from the headphones, while in the TransAcoustic mode (page 20) or Layer mode (page 21), the sound is output from the soundboard.

Before using the Bluetooth function, be sure to read “About Bluetooth” on page 8. Depending on the country in which you purchased the product, the instrument may not have Bluetooth capability.

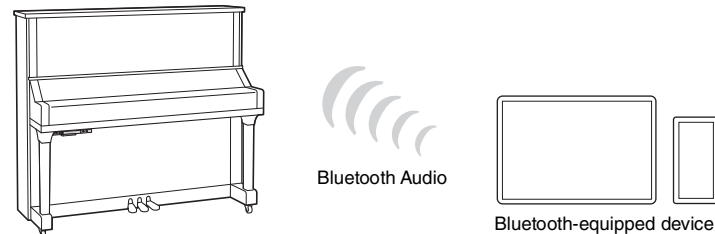

### NOTE

In this manual, “Bluetooth-equipped device” refers to a device that can transmit audio data on it to the instrument using the Bluetooth function, via wireless communication. For proper operation, the device must be compatible with A2DP (Advanced Audio Distribution Profile). The Bluetooth Audio function is explained here by using a smart device as an example of such Bluetooth-equipped devices. This instrument cannot transmit audio data to devices via Bluetooth. Thus, any Bluetooth headphones and Bluetooth speakers cannot be connected.

- 1 Press the Menu button several times until the [UTILITY] lamp lights up in orange.

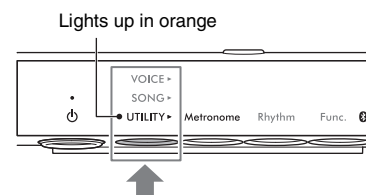

- 2 Hold down Button 3 [Func.] for two seconds to put pairing in standby.

The Bluetooth lamp will flash in blue and a “bt” message will appear on the display.

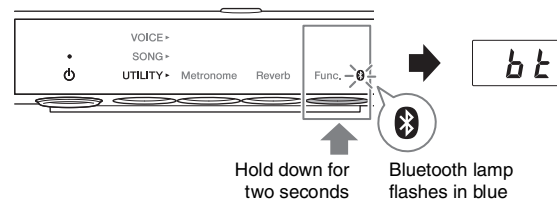

### NOTE

- “Pairing” means to register Bluetooth-equipped devices on this instrument, and establish mutual recognition for wireless communication between the two.
- The Bluetooth function of the instrument should be on (the Bluetooth lamp should light up in white) to start pairing. It is set to on by default. The Bluetooth function can be turned on/off in Function F7.5 (page 51). The Bluetooth lamp lights up when UTILITY is selected and turns off when VOICE or SONG is selected.
- Only one Bluetooth-equipped device can be connected to this instrument at a time (although up to 8 Bluetooth-equipped devices can be paired to this instrument). When pairing with the 9th Bluetooth-equipped device has succeeded, pairing data for the device with the oldest connection date will be deleted.
- The pairing operation can also be done by Function F7.6 (page 52). After enabling pairing, go on to step 3 here.
- To cancel pairing, press Button 3 [Func.] while “bt” is shown in the display.

### **3 On the Bluetooth-equipped device, set the Bluetooth function to on and select “YAMAHA \*\*\* AUDIO” (\*\*\*) indicates the model name) from the connection list.**

For details, refer to the Bluetooth-equipped device’s manual. After pairing is completed, the Bluetooth lamp will light up in blue and the “bt” message will disappear.

#### **NOTE**

- Make sure to complete the settings on the Bluetooth-equipped device within 5 minutes. After 5 minutes elapses, the pairing standby status is canceled automatically.
- If you are required to enter a passkey, enter the numerals “0000.”

### **4 Play back audio data on the Bluetooth-equipped device to confirm that the sound can be output from this instrument.**

When you turn on the instrument the next time, the Bluetooth-equipped device will be connected to this instrument automatically, if the Bluetooth function of the device and the instrument is set to on. If it is not connected automatically, select the model name of the instrument from the connection list on the device.

#### **NOTE**

You can adjust the volume of the sound input via Bluetooth by the [VOLUME] control on this instrument. To adjust the volume balance between your keyboard performance and the input sound via Bluetooth, adjust the volume on the Bluetooth-equipped device.

# Connecting with the smart device app “Smart Pianist”

TA3 SH3 SC3

By connecting a smart device such as a smartphone or tablet and using the Smart Pianist app, you can view the score of the preset Songs on the smart device, record your performance to the smart device, and perform other convenient operations. The intuitive visual interface helps you to confirm the current settings of the instrument.



For details on the app and compatible devices, see the website below or search “Yamaha Smart Pianist” on a web search engine.

<https://www.yamaha.com/kbdapps/>

After installing the Smart Pianist app on your smart device, connect this instrument to the device via USB cables, Bluetooth or Wi-Fi.

## NOTICE

- All settings on the instrument are replaced by the settings on Smart Pianist when the instrument is connected with Smart Pianist.
- Do not place the smart device in an unstable position. Doing so may cause the device to fall and result in damage.

## Connecting via USB cables

You can connect a smart device to the [USB TO HOST] terminal by using USB cables. For details on connection, refer to the “Smart Pianist User Guide” on the website (page 11).

## NOTICE

Use an AB type USB cable of less than 3 meters. USB 3.0 cables cannot be used.

## Connecting via Bluetooth

Before using the Bluetooth function, be sure to read “About Bluetooth” on page 8. Depending on the country in which you purchased the product, the instrument does not have Bluetooth capability.

## NOTE

- To connect via Bluetooth, make sure that the Bluetooth function is turned on (Bluetooth lamp is lit). It is set to on by default. The Bluetooth on/off setting can be changed in Function F7.5 (page 51).
- This instrument cannot transmit audio data to the smart devices via Bluetooth. Thus, when the device is connected by Bluetooth, you cannot record in audio format by using Smart Pianist. If you want to record while Bluetooth connection is enabled, record in MIDI format. You can record in audio format when the instrument is connected to the smart device in a method other than Bluetooth.

**1** Make the Bluetooth Audio function settings on this instrument to receive audio data (page 59).

**2** Connect with the smart device via Bluetooth MIDI by using Smart Pianist.  
For details on connection, refer to the “Smart Pianist User Guide” on the website (page 11). When the connection is successful, the MIDI data can be transmitted/received between the instrument and the smart device.

## Connecting via Wi-Fi (wireless LAN)

For Wi-Fi connection, a separately sold USB wireless LAN adaptor (UD-WL01) is required. The UD-WL01 may not be available depending on your area. Before connecting the USB wireless LAN adaptor, be sure to read “Connecting USB devices” on page 55.

### NOTICE

**Do not connect this product to a public Wi-Fi and/or Internet service directly. Only connect this product to the Internet through a router with strong password protections. Consult your router manufacturer for information on optimum security practices.**

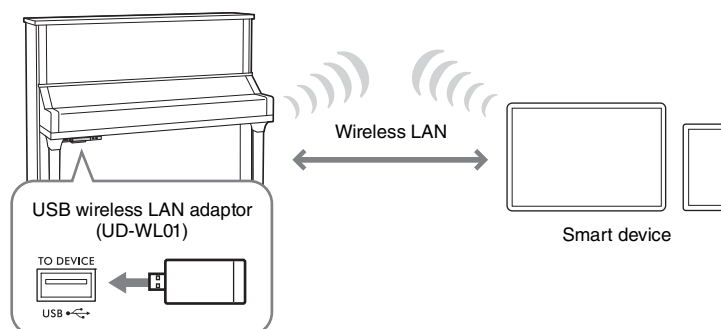

There are two types of connections via Wi-Fi as described below. For details on connection, refer to the “Smart Pianist User Guide” on the website (page 11).

### ■ Connecting by the Access Point mode

The Access Point mode allows you to directly connect the USB wireless LAN adaptor and a smart device, without the need for using an access point. You can use this mode when there is not any access point available for connection to the instrument, or when it is unnecessary to connect to another network while a smart device is connected to the instrument. When connected by this mode, Internet access is disabled on your smart device, and some functions of Smart Pianist cannot be used.

If you switch from the Infrastructure mode to the Access Point mode, initialize the instrument (page 54) before connecting.

### ■ Connecting by the Infrastructure mode (automatic setup by WPS)

The Infrastructure mode uses an access point for data communication between a USB wireless LAN adaptor and a network. You can use this mode when you connect to another network while a smart device is connected to the instrument.

When a message as shown at right appear on the display of this instrument during the connection procedure, press the WPS button on your access point within two minutes.



### NOTE

An “access point” refers to a device which acts as a base station when data is transmitted/received via a USB wireless LAN adaptor. Some access points are combined with router or modem functions.

## Connecting to a computer ([USB TO HOST] terminal)

TA3 SH3 SC3

By connecting a computer to the [USB TO HOST] terminal via a USB cable, you can transfer MIDI data or Audio data between the instrument and the computer. For details on using a computer with this instrument, refer to the “Computer-related Operations” on the website (page 11).

### ⚠ CAUTION

If you are using a DAW (digital audio workstation) application with this instrument, set Audio Loopback (page 64) to off. Otherwise, a loud sound may occur, depending on the settings of the computer or the application software.

#### Example:

Control unit bottom panel

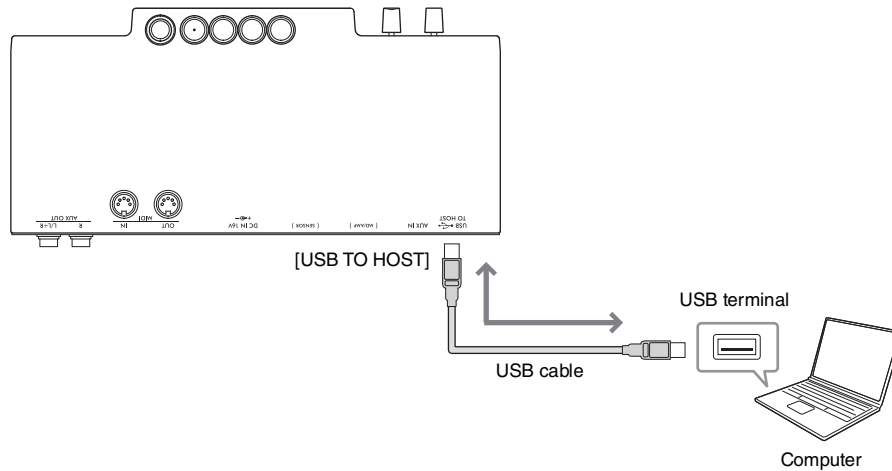

### NOTICE

- Use an AB type USB cable of less than 3 meters. USB 3.0 cables cannot be used.
- Do not place your computer in an unstable position. Doing so may cause the device to fall and result in damage.

### NOTE

- When using a USB cable to connect the instrument to your computer, make the connection directly without passing through a USB hub.
- The instrument will begin transmission a short time after the computer is connected.
- For information on setting up your computer and/or software, refer to the relevant documentation.
- Unexpected sounds may occur if you edit MIDI data related to the Grand Expression Modeling function (page 53) on a computer.

## Transmitting/receiving audio data (USB Audio Interface function)

By connecting a computer or a smart device to the [USB TO HOST] terminal via a USB cable, digital audio data can be transmitted/received. This USB Audio Interface function provides the following advantages:

- **Playing back audio data input from the computer with high sound quality on this instrument**  
This gives you direct, clear sound in which the sound quality has less noise and deterioration than that from the [AUX IN] jack.
- **Recording digital sound played on this instrument as audio data by using recording software or music production software on the computer**  
The recorded audio data can be played back on the computer or smart device.

### NOTE

- When transmitting or receiving audio signals by using a computer running Windows, the Yamaha Steinberg USB Driver should be installed to the computer. For details, refer to the “Computer-related Operations” on the website (page 11).
- The volume of the audio sound input can be adjusted from a computer or smart device.

## Turning Audio Loopback on/off

The Audio Loopback function allows you to set whether audio input from the computer or smart device by the USB Audio Interface function (page 63) or by Smart Pianist with Wi-Fi connection (page 62), is output to a computer or a smart device or not along with the performance played on the instrument. To output the audio input, set the Audio Loopback to on. For example, if you want to record the audio input sound as well as the sound played on the instrument by using the connected computer or smart device, set this to on. If you intend to record only the sound played on the instrument by using the computer or smart device, set this to off. This function is set to on by default. The on/off setting can be changed in the Function F8.3 (page 52).

## Connecting to a MIDI device (MIDI terminals)

TA3 SH3 SC3

By connecting a MIDI device, you can control an external MIDI device from this instrument or vice versa. Use the MIDI terminals and standard MIDI cables to connect external MIDI devices (keyboard, synthesizer, sequencer, etc.).

- **MIDI [IN]:** Receives MIDI messages from another MIDI device.
- **MIDI [OUT]:** Transmits MIDI messages generated on this instrument to another MIDI device.

### Example:

Control unit bottom panel

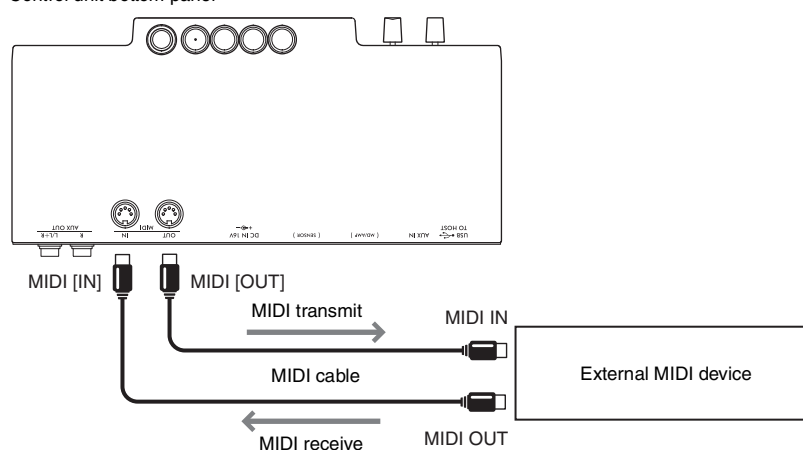

### NOTE

- For details about MIDI, refer to the “MIDI Basics” document, downloadable from the website (page 11).
- Since MIDI data that can be transmitted or received varies depending on the type of MIDI device, check the “MIDI Reference” on the website (page 11) to find out what MIDI data and commands your devices can transmit or receive.
- Voice Demo Song data and Preset Song data cannot be transmitted.
- When the instrument is connected to Smart Pianist, MIDI messages cannot be output from the MIDI [OUT] terminal.
- When transmitting MIDI data from this instrument to an external MIDI device, unexpected sounds may occur because of data related to the Grand Expression Modeling function (page 53).



# Appendix

## Message List

Message	Description
<i>b t</i>	The instrument is standing by for Bluetooth pairing (page 59). While this message is shown, you cannot operate the instrument.
<i>CLr</i>	The instrument is being initialized (page 54). Do not turn the power off while this message is shown.
<i>CON</i>	The instrument is connected to a smart device and the app “Smart Pianist” is being used (page 61). While this message is shown, control the instrument by using Smart Pianist. To disconnect, close Smart Pianist on the smart device.
<i>E 0 1</i>	The Character Code setting (page 37) is not appropriate for the file name of the Song which you are selecting. Change the Character Code setting.
	The data format is not compatible with this instrument, or the data has some other problems. This Song cannot be selected.
	The memory or the number of the files in the copy destination USB flash drive is full. Delete any unnecessary Songs or files in the USB flash drive (page 35).
	The Song you have selected cannot be copied or deleted on this instrument. Copy or delete these types of Songs on a computer.
<i>E 0 2</i>	No USB flash drive can be found, or a problem has occurred in the USB flash drive. Disconnect and connect the USB flash drive again, and then execute the operation again. If this message appears repeatedly even when there aren't any other likely problems, the USB flash drive may be damaged.
<i>E 0 3</i>	Indicates that the USB flash drive is write-protected. Disable write-protect before using.
<i>E 0 4</i>	The memory of the USB flash drive has become full, or the number of files and folders exceeds the system limit.
<i>E 0 4</i>	Audio Song playback or recording has failed. If you are using a USB flash drive to which data has already been stored or deleted a number of times, first make sure that the USB flash drive does not contain important data, and then format it (page 56) to use it on this instrument.
<i>EE 1</i> - <i>EE 6</i>	A malfunction has occurred in the instrument. Contact your nearest Yamaha dealer or authorized distributor.
<i>End</i>	The operation has been completed.
<i>EnP</i>	The available memory of the instrument or the USB flash drive is at a low level. We recommend that you remove any unnecessary User Songs (page 35) to ensure sufficient memory capacity before starting to record.
<i>FUL</i>	The operation could not be completed because the available memory of the instrument or the USB flash drive is nearly empty. If this message is shown while recording, your performance data may not be correctly saved.
<i>n y</i>	This is a confirmation prompt asking if you are sure you want to delete the User Song (page 35) or format the USB flash drive (page 56). Press Button 3 [Func.] to execute. Pressing a button other than Button 3 [Func.] cancels the operation.
<i>Pr o</i>	The selected Song is a read-only file and cannot be deleted or overwritten.
<i>UnF</i>	An unformatted USB flash drive is connected. First make sure that the USB flash drive does not contain important data, and then format it (page 56).

Message	Description
<i>U O C</i>	Communication with the USB flash drive has been shut down because of overcurrent to the USB flash drive. Disconnect the USB flash drive from the [USB TO DEVICE] terminal, and then turn on the power of the instrument again.
<i>U U 1</i>	Communication with the USB flash drive has failed. Remove the USB flash drive and make the connection again. If the message appears even when the USB flash drive is connected properly, try using another USB flash drive.
<i>U U 2</i>	This USB flash drive is not supported on this instrument, or too many USB flash drives may have been connected. Refer to "Using USB Flash Drives" (page 55) for information on the USB flash drive connection.
<i>W P S</i>	The instrument is in standby for connection to an access point by WPS (page 62). While this message is shown, you cannot operate the instrument.
<i>W.P.S.</i>	A malfunction occurred in the instrument while it was standing by for connection to an access point by WPS (page 62). Reconnect the USB wireless LAN adaptor (UD-WL01; sold separately) to the instrument and try to connect to the access point by WPS again.

\* When an operation (such as saving or data transfer) is in progress, the display shows a sequence of flashing dashes.

\* Press any button to exit from these message displays.

# Troubleshooting

If you have problems with the unit, here are a few troubleshooting tips. If you cannot solve the problem easily yourself, consult your Yamaha piano dealer. DO NOT attempt to repair the instrument yourself.

When a message is shown in the display, check the Message List on page 65.

Problem	Possible Cause and Solution
The power does not turn on.	The AC adaptor and power cord may not be plugged in correctly. Make sure that the plugs are securely inserted (page 14).
The power is automatically turned off.	This is normal and due to the Auto Power Off function. If necessary, disable the Auto Power Off function (page 16).
The overall volume is low, or no sound is heard.	The volume is set too low; set it to an appropriate level using the [MASTER VOLUME] control (pages 19, 21).
	The Voice is set to “---.” Select a Voice other than “---” (page 22).
	Local Control is set to off. Set Local Control to on in Function F7.2 (page 51).
The acoustic piano sound can be heard even when playing not in the Acoustic mode.	Playing with extreme force may result in acoustic piano sound being emitted. Moderate the strength of your playing.
The balance or volume varies between the included headphones and commercially available headphones.	Headphone properties differ depending on their type, so different headphones may have different balance or volume characteristics. Use the same type of headphones for optimum performance.
A rattling sound from the piano body can be heard when playing in the Quiet mode/ TransAcoustic mode.	This is not a fault. It is the sound of the acoustic piano’s keystroke.
When playing a rapid series of notes in the Quiet mode/TransAcoustic mode/Layer mode, a sound louder than expected (considering playing strength) occurs.	This is not a fault. The structure of the TransAcoustic™ Piano or the Silent Piano™ causes this to occur in some cases.
Rhythm does not start.	The Synchro Start function is set to on. Pressing any key starts Rhythm playback. The Synchro Start function can be turned on/off in Function F6.5 (page 51).
Metronome, MIDI Song or Rhythm goes out of tempo slightly when you play the keyboard.	This occurs infrequently when Grand Expression Modeling is set to “Dynamic.” If this happens, set Grand Expression Modeling to “Static” in Function F2.7 (page 46).
No Reverb effect is applied to the sound even when it is turned on.	The Reverb Depth may be set to minimum. Adjust the Reverb Depth in Function F1.2 (page 45).
	(Only on the TA3) When the [TA] lamp is lit (when in the TransAcoustic mode or Layer mode), the Reverb effect is automatically turned off and no effect is applied.
The sound lingers excessively.	The Reverb Depth (Function F1.2) or the Damper Resonance (Function F2.2) may be set to an excessive level. Set these parameters to an appropriate levels (pages 45, 46).
Noise is heard from the instrument.	The noise may be due to interference caused by the use of a mobile phone in close proximity to the instrument. Turn off the mobile phone, or use it further away from the instrument.
	The noise may be due to interference caused by the use of a smart device phone in close proximity to the instrument. When you connect a smart device with the instrument wirelessly, we recommend that you set that device’s “Airplane Mode” to on and then the Wi-Fi/Bluetooth setting to on on your smart device, in order to avoid noise caused by communication.
The pitch of this instrument is different from that of other instruments.	The pitch is different depending on the instrument. You can adjust the pitch of this instrument in Function F3.4 (page 47) to match that of other instruments.

Problem	Possible Cause and Solution
The Bluetooth-equipped device (such as smart device) cannot be connected to the instrument.	The Bluetooth function is turned off on this instrument or on the Bluetooth-equipped device. Make sure that the Bluetooth function is turned on both devices. The Bluetooth on/off of this instrument can be set in Function F7.5 (page 51).
	The Bluetooth-equipped device is not paired with this instrument. The device and this instrument need to be paired to each other (page 59).
	This instrument and the Bluetooth-equipped device are too far apart. Use the device in close proximity to this instrument.
	There is a device (microwave oven, wireless LAN device, etc.) that outputs signals in the 2.4 GHz frequency band nearby. Move the instrument away from any devices that might be emitting radio-frequency signals.
Sound input via Bluetooth is interrupted.	The output volume of the Bluetooth-equipped device connected to this instrument is too low, resulting in the sound being cut off via the Noise Gate after it is input to this instrument. Increase the output volume of the device. The volume level reproduced via this instrument can be adjusted by using the [VOLUME] control.
Sound input to the [AUX IN] jacks is interrupted.	The output volume of the external device connected to the [AUX IN] jack is too low. Increase the output volume of the external device. The volume level reproduced via this instrument can be adjusted by using the [VOLUME] control. The AUX IN Noise Gate function may cut off wanted soft sounds; if this happens, set the function to off in Function F8.2 (page 52).

# Voice List

The cells marked by “✓” indicate the available characteristics (explained below) for the Voice.

- **Stereo Sampling:** Stereo sampling is used for the Voice.
- **Touch Sensitivity:** The volume responds to your playing strength.
- **Key-off Sampling:** The key-off sound (the subtle sound that occurs when you release a key) is sampled for the Voice.

## NOTE

- VRM is effective for Voices in the “Piano” category. For details about VRM, refer to page 53.
- Grand Expression Modeling is effective for the Voices of “CFX Grand” and “Bösendorfer.” For details about Grand Expression Modeling, refer to page 53.

Voice Number		Voice Name	Description	Touch Sensitivity	Stereo Sampling	Key-off Sampling
TA3/SH3	SC3					
<b>Piano</b>						
<i>PF1</i>	<i>PF1</i>	CFX Grand	Yamaha’s CFX concert grand piano sound with a wide dynamic range for maximum expressive control. Suitable for playing in any music genre and style. This is available when the Binaural setting is turned off (page 49).	✓	✓	✓
		Binaural CFX Grand	Yamaha’s CFX concert grand piano sound sampled by Binaural Sampling, the method optimized for headphone use. Listening to this through headphones gives the impression of being immersed in the sound, as if it was actually emanating from the piano. This is available when the Binaural setting is turned on (page 49).			
<i>PF2</i>	<i>PF2</i>	Bösendorfer	The famed sound of the Vienna-made Bösendorfer Imperial concert grand piano. Its warm, spacious sound evokes the size of the instrument, and is ideal for expressing tenderness in compositions. This is available when the Binaural setting is turned off (page 49).	✓	✓	✓
		Binaural Bösendorfer	The famed sound of the Vienna-made Bösendorfer Imperial concert grand piano sampled by Binaural Sampling, the method optimized for headphone use. Listening to this through headphones gives the impression of being immersed in the sound, as if it was actually emanating from the piano. This is available when the Binaural setting is turned on (page 49).			
<i>PF3</i>	—	Pop Grand	A slightly brighter piano sound. Good for popular styles.	✓	✓	✓
<i>PF4</i>	—	Ballad Grand	Grand piano sound with a soft and warm tone. Good for playing ballads.	✓	✓	✓
<i>PF5</i>	<i>PF3</i>	Upright Piano	The sound sampled from an upright piano, the Yamaha SU7. Enjoy the unique tonal character and a lighter, more casual feel.	✓	✓	—

Voice Number		Voice Name	Description	Touch Sensitivity	Stereo Sampling	Key-off Sampling
TA3/SH3	SC3					
<b>Fortepiano</b>						
<b>FP1</b>	—	Scarlatti Piano	The sound of a piano made by a musical instrument maker in Florence in the early 18th century. The maker is famous for inventing the piano. It is believed that Scarlatti used the piano made by the maker. The sound is bright and brilliant.	✓	✓	✓
<b>FP2</b>	—	Mozart Piano	The sound of a piano made by a musical instrument maker in Vienna in the late 18th century. Mozart and Beethoven played and highly appreciated the pianos made by this manufacturer. Its sound is clear and light.	✓	✓	—
<b>FP3</b>	—	Beethoven Piano	The sound of a piano made by a piano manufacturer in London in the early 19th century. Haydn and Beethoven composed many masterpieces inspired by the pianos of this manufacturer. It features a rich bass, sparkling highs and energetic fortissimo.	✓	✓	✓
<b>FP4</b>	—	Chopin Piano	The sound of a piano made by a piano manufacturer in Paris in the 19th century. Chopin deeply loved the pianos of this manufacturer, which responded well to his sensitive touch. It has a sound like a singing voice, sometimes luscious, sometimes mournful.	✓	✓	—
<b>E.Piano</b>						
<b>EP1</b>	<b>EP1</b>	Stage E.Piano	The sound of an electric piano using hammer-struck metallic “tines.” Soft tone when played lightly, and an aggressive tone when played hard.	✓	—	✓
<b>EP2</b>	<b>EP2</b>	DX E.Piano	An electronic piano sound produced by an FM synthesizer. The tone changes as you vary your playing touch. Ideal for popular music.	✓	—	—
<b>EP3</b>	<b>EP3</b>	Vintage EP	The sound of an electric piano using hammer-struck metal reeds. Widely used in rock and popular music.	✓	—	✓
<b>Harpsichord</b>						
<b>HS1</b>	<b>HS1</b>	Harpsichord 8'	The sound of the harpsichord frequently used in baroque music. Variations in playing touch will not affect the volume, and a characteristic sound will be heard when you release the key.	—	✓	✓
<b>HS2</b>	—	Harpsi. 8'+4'	A harpsichord with an added upper octave. Produces a more brilliant sound.	—	✓	✓
<b>HS3</b>	—	Vibraphone	A Vibraphone sound with spacious and clear tone. Pressing the left pedal switches Vibrato on and off.	✓	✓	—
<b>HS4</b>	<b>HS2</b>	Celesta	The sound of a celesta (a percussion instrument in which hammers strike metallic bars to produce sound). This instrument is well-known for its use in “Dance of the Sugar-plum Fairies” from Tchaikovsky’s “Nutcracker Suite.”	✓	✓	—

Voice Number		Voice Name	Description	Touch Sensitivity	Stereo Sampling	Key-off Sampling
TA3/SH3	SC3					
<b>Organ</b>						
<i>Or 1</i>	<i>Or 1</i>	Organ Principal	This Voice features the combination of pipes (8'+4'+2') of a principal (brass instrument) organ. It is suitable for Baroque church music.	—	✓	—
<i>Or 2</i>	—	Organ Tutti	This Voice features a full coupler of a pipe organ, famous for the sound used in “Toccatina and Fugue” by Bach.	—	✓	—
<i>Or 3</i>	<i>Or 2</i>	Jazz Organ	The sound of an electric organ often heard in jazz and rock idioms. Pressing the left pedal switches the speed of Rotary Speaker effect between slow and fast.	—	—	—
<b>Pad</b>						
<i>Pd 1</i>	<i>Pd 1</i>	Strings	The sound of large-scale strings ensemble, with a slow attack.	✓	✓	—
<i>Pd 2</i>	—	Choir	A big, spacious choir Voice. Perfect for creating rich harmonies in slow pieces.	✓	✓	—
<i>Pd 3</i>	<i>Pd 2</i>	Synth Pad	A warm, mellow, and spacious synth sound.	✓	—	—
<b>Layer</b>						
<i>Ly 1</i>	—	Piano + Strings	Combination of piano and strings ensemble Voices, giving you a richly textured sound as if you were playing the piano with orchestral accompaniment.	✓	✓	✓
<i>Ly 2</i>	—	Piano + Pad	Combination of piano and Synth Pad Voices.	✓	✓	✓
<i>Ly 3</i>	—	Piano + DX E.Piano	Combination of piano and DX E. Piano Voices.	✓	✓	✓

# Song List

## Voice Demo Songs

Song No.		Voice Name	Song Name	Composer
TA3/SH3	SC3			
d01	d01	CFX Grand (Binaural CFX Grand)	24 Preludes Vivace C-Dur	A. Scriabin
d02	d02	Bösendorfer (Binaural Bösendorfer)	Widmung, S. 566, R. 253	F. Liszt
d03	—	Pop Grand	Original	—
d04	—	Ballad Grand	Original	—
d05	d03	Upright Piano	Italienisches Konzert, BWV.971-1 1st mov.	J. S. Bach
d06	—	Scarlatti Piano	Sonata G dur K.14 L.387	D. Scarlatti
d07	—	Mozart Piano	Sontata No.15 C dur K.545 1st mov.	W. A. Mozart
d08	—	Beethoven Piano	Für Elise a moll	L. v. Beethoven
d09	—	Chopin Piano	Nocturne op.27-2 Des dur	F. F. Chopin
d.10	d04	Stage E.Piano	Original	—
d.11	d05	DX E.Piano	Original	—
d.12	d06	Vintage EP	Original	—
d.13	d07	Harpsichord 8'	Concerto a cembalo obbligato, 2 violini, viola e continuo No.7 g moll BWV 1058 1st mov.	J. S. Bach
d.14	—	Harpsi. 8'+4'	Gigue, French Suite No. 5, BWV 816	J. S. Bach
d.15	—	Vibraphone	Original	—
d.16	d08	Celesta	Dance of the Sugar Plum Fairy	P. I. Tchaikovsky
d.17	d09	Organ Principal	Herr Christ, der ein'ge Gottes-Sohn, BWV 601	J. S. Bach
d.18	—	Organ Tutti	Original	—
d.19	d.10	Jazz Organ	Original	—
d20	d.11	Strings	Original	—
d21	—	Choir	Original	—
d22	d.12	Synth Pad	Original	—
d23	—	Piano + Strings	Original	—



Song No.		Voice Name	Song Name	Composer
TA3/SH3	SC3			
<b>d.24</b>	—	Piano + Pad	Original	—
<b>d.25</b>	—	Piano + DX E.Piano	Original	—

The Demo Songs excluding original Songs are short rearranged excerpts from the original compositions. The “Original” Demo Songs are Yamaha originals (©Yamaha Corporation).

## Preset Songs

Song No.	Song Name	Composer
<b>Arrangements</b>		
<b>P.01</b>	Canon D dur	J. Pachelbel
<b>P.02</b>	Air On the G String	J. S. Bach
<b>P.03</b>	Jesus, Joy of Man's Desiring	J. S. Bach
<b>P.04</b>	Twinkle, Twinkle, Little Star	Traditional
<b>P.05</b>	Piano Sonate op.31-2 "Tempest" 3rd mov.	L. v. Beethoven
<b>P.06</b>	Ode to Joy	L. v. Beethoven
<b>P.07</b>	Wiegenlied op.98-2	F. P. Schubert
<b>P.08</b>	Grande Valse Brillante	F. F. Chopin
<b>P.09</b>	Polonaise op.53 "Héroïque"	F. F. Chopin
<b>P.10</b>	La Campanella	F. Liszt
<b>P.11</b>	Salut d'amour op.12	E. Elgar
<b>P.12</b>	From the New World	A. Dvořák
<b>P.13</b>	Sicilienne	G. U. Fauré
<b>P.14</b>	Clair de lune	C. A. Debussy
<b>P.15</b>	Jupiter (The Planets)	G. Holst

Song No.	Song Name	Composer
<b>Duets</b>		
<b>P.16</b>	Menuett (Eine kleine Nachtmusik K.525)	W. A. Mozart
<b>P.17</b>	Menuett G dur	L. v. Beethoven
<b>P.18</b>	Marcia alla Turca	L. v. Beethoven
<b>P.19</b>	Piano Concerto No.1 op.11 2nd mov.	F. F. Chopin
<b>P.20</b>	The Nutcracker Medley	P. I. Tchaikovsky
<b>Original Compositions</b>		
<b>P.21</b>	Prelude (Wohltemperierte Klavier I No.1)	J. S. Bach
<b>P.22</b>	Menuett G dur BWV Anh.114	J. S. Bach
<b>P.23</b>	Piano Sonate No.15 K.545 1st mov.	W. A. Mozart
<b>P.24</b>	Turkish March	W. A. Mozart
<b>P.25</b>	Piano Sonate op.13 "Pathétique" 2nd mov.	L. v. Beethoven
<b>P.26</b>	Für Elise	L. v. Beethoven
<b>P.27</b>	Piano Sonate op.27-2 "Mondschein" 1st mov.	L. v. Beethoven
<b>P.28</b>	Impromptu op.90-2	F. P. Schubert

Song No.	Song Name	Composer
<b>P.29</b>	Frühlingslied op.62-6	J. L. F. Mendelssohn
<b>P.30</b>	Fantaisie-Impromptu	F. F. Chopin
<b>P.31</b>	Etude op.10-3 "Chanson de l'adieu"	F. F. Chopin
<b>P.32</b>	Etude op.10-12 "Revolutionary"	F. F. Chopin
<b>P.33</b>	Valse op.64-1 "Petit chien"	F. F. Chopin
<b>P.34</b>	Nocturne op.9-2	F. F. Chopin
<b>P.35</b>	Nocturne KK4a-16/BI 49 [Posth.]	F. F. Chopin
<b>P.36</b>	Träumerei	R. Schumann
<b>P.37</b>	Barcarolle	P. I. Tchaikovsky
<b>P.38</b>	La prière d'une Vierge	T. Badarzewska
<b>P.39</b>	Liebesträume No.3	F. Liszt

Song No.	Song Name	Composer
<b>P.40</b>	Blumenlied	G. Lange
<b>P.41</b>	Humoresque	A. Dvořák
<b>P.42</b>	Arietta	E. H. Grieg
<b>P.43</b>	Tango (España)	I. Albéniz
<b>P.44</b>	The Entertainer	S. Joplin
<b>P.45</b>	Maple Leaf Rag	S. Joplin
<b>P.46</b>	La Fille aux Cheveux de Lin	C. A. Debussy
<b>P.47</b>	Arabesque No.1	C. A. Debussy
<b>P.48</b>	Cakewalk	C. A. Debussy
<b>P.49</b>	Je te veux	E. Satie
<b>P.50</b>	Gymnopédies No.1	E. Satie

# Specifications

(\*) The items with asterisks are for models equipped with a sostenuto pedal.

			TA3	SH3	SC3
<b>Product Name</b>			TransAcoustic™ Piano	SILENT Piano™	
<b>Silencing System</b>	<b>Mechanism</b>		Hammer shank stopper (Grand pianos: operated by motor drive or silencing lever, Upright pianos: operated by silencing lever* or silencing pedal)		
	<b>Action (only for grand pianos)</b>		Quick Escape mechanism		
<b>Soundboard Drive System</b>	<b>Mechanism</b>		TransAcoustic™ technology	—	
	<b>Transducer</b>		Exclusively for TA3	—	
<b>Control Interface</b>	<b>Keyboard</b>	<b>Touch Response</b>	Soft, Soft/Medium, Medium, Medium/Hard, Hard, Fixed		
	<b>Pedal</b>		Damper, Sostenuto*/Silencing, Soft		
	<b>Display</b>	<b>Type</b>	7-Segment LED		
	<b>Panel</b>	<b>Language</b>	English		
<b>Sensor System</b>	<b>Key Sensors</b>	<b>System</b>	Articulation sensor system		
		<b>Key Sensors</b>	Non-contact continuous detection electromagnetic inductive type		
		<b>Hammer Sensors (only for grand pianos)</b>	Non-contact 2-point optical fiber type	—	
	<b>Pedal Sensors</b>	<b>Damper Pedal</b>	Continuous detection sensor		
		<b>Sostenuto Pedal*</b>	On/Off detection sensor	—	
		<b>Soft Pedal</b>	On/Off detection sensor		
<b>Voices</b>	<b>Tone Generation</b>	<b>Piano Sound</b>	Yamaha CFX, Bösendorfer Imperial		
		<b>Binaural Sampling</b>	Yes (“CFX Grand” and “Bösendorfer” only)		
	<b>Piano Effects</b>	<b>VRM (Virtual Resonance Modeling)</b>	Yes		
		<b>Grand Expression Modeling</b>	Yes		
		<b>Key-off Samples</b>	Yes		
		<b>Smooth Release</b>	Yes		
	<b>Polyphony (max.)</b>		256		
	<b>Preset</b>	<b>Number of Voices</b>	25 (Piano 5 + Fortepiano 4 + Others 16)	12 (Piano 3 + Others 9)	
	<b>Voices for Song Playback</b>		480 XG Voices + 12 Drum/SFX Kits	—	
<b>Effects</b>	<b>Types</b>	<b>Reverb</b>	6 types		
		<b>Brilliance</b>	5 types		
		<b>Intelligent Acoustic Control (IAC)</b>	Yes		
		<b>Stereophonic Optimizer</b>	Yes (piano Voices other than “CFX Grand” and “Bösendorfer”)		
<b>Songs (MIDI)</b>	<b>Preset</b>	<b>Number of Preset Songs</b>	25 Voice Demo Songs, 50 Classics	12 Voice Demo Songs, 50 Classics	
	<b>Recording</b>	<b>Number of Songs</b>	10		
		<b>Data Capacity</b>	approx. 500 KB / Song		

			TA3	SH3	SC3
<b>Songs (MIDI)</b>	<b>Format</b>	<b>Playback</b>	SMF (Format 0, Format 1)		
		<b>Recording</b>	SMF (Format 0)		
<b>Songs (Audio)</b>	<b>Recording Time (max.)</b>		80 minutes / Song		
	<b>Format</b>	<b>Playback</b>	WAV (44.1 kHz, 16 bit, stereo)		
		<b>Recording</b>	WAV (44.1 kHz, 16 bit, stereo)		
<b>Functions</b>	<b>Rhythms</b>	<b>Number of Rhythms</b>	20		
	<b>Overall Controls</b>	<b>Metronome</b>	Yes		
		<b>Tempo Range</b>	5–500		
		<b>Transpose</b>	–12–0–+12		
		<b>Tuning</b>	414.8–440.0–466.8 Hz (approx. 0.2 Hz increments)		
	<b>USB audio interface</b>		44.1 kHz, 24 bit, stereo		
<b>Bluetooth</b> (May not have this functionality depending on the country in which you purchased the product.)	<b>Audio</b>	<b>Supported profile</b>	A2DP		
		<b>Compatible codec</b>	SBC		
	<b>MIDI</b>		Comply with Bluetooth Low Energy MIDI Specification		
	<b>Bluetooth version</b>		4.2		
	<b>Wireless output</b>		Bluetooth class 2		
	<b>Maximum communication distance</b>		Approx. 10 m		
	<b>Radio Frequency (Operational Frequency)</b>		2402–2480 MHz		
	<b>Maximum output power (EIRP)</b>		4 dBm		
	<b>Type of modulation</b>		FHSS		
<b>Storage and Connectivity</b>	<b>Storage</b>	<b>Internal Memory</b>	Approx. 1.3 MB		
		<b>External Drives</b>	USB flash drive		
	<b>Connectivity</b>	<b>DC IN</b>	24 V	16 V	
		<b>Headphones</b>	Stereo mini jack (× 2)		
		<b>MIDI</b>	[IN], [OUT]	—	
		<b>AUX IN</b>	Stereo mini jack		
		<b>AUX OUT</b>	[L/L+R], [R] (Standard phone jack)	—	
		<b>USB TO DEVICE</b>	Yes		
		<b>USB TO HOST</b>	Yes		
<b>Power Supply</b>	<b>AC Adaptor</b>		PA-500	PA-300C	
		<b>Output</b>	DC 24 V, 2.5 A	DC 16 V, 2.4 A	
		<b>Polarity</b>	+ ⊖ -	+ ⊖ -	
	<b>Power Consumption</b>		26 W (When using PA-500 AC adaptor)	8 W (When using PA-300C AC adaptor)	
	<b>Auto Power Off</b>		Yes		
<b>Included Accessories</b>			Owner's Manual, "50 Classical Music Masterpieces" music book (TA3/SH3 only), headphones, headphone hanger, attachment screws for headphone hanger, AC adaptor*, power cord* *May not be included depending on your area. Check with your Yamaha dealer.		
<b>Separately Sold Accessories</b> (May not be available depending on your area.)			USB wireless LAN adaptor (UD-WL01), AC adaptor (TA3: PA-500, SH3/SC3: PA-300C)		

The contents of this manual apply to the latest specifications as of the publishing date. To obtain the latest manual, access the Yamaha website then download the manual file. Since specifications, equipment or separately sold accessories may not be the same in every locale, please check with your Yamaha dealer.

# Index

---

## A

Access Point mode .....	62
Accessories .....	11
Acoustic mode .....	17
App .....	61
Audio EQ .....	49
Audio Loopback .....	52, 64
Audio recording .....	29
Audio Song .....	24
Auto Power Off .....	16, 52
[AUX IN] jack .....	58
AUX IN Noise Gate .....	52
AUX OUT jacks .....	57

## B

Backup .....	51
Backup data .....	54
Bass .....	51
Beat .....	39
Binaural Sampling .....	19, 49
Bluetooth .....	8, 51, 61
Bluetooth Audio .....	59
Body Resonance .....	46
Brilliance .....	49

## C

Character code .....	37
Computer .....	63
Computer-related Operations .....	11
Control unit .....	12
Copy (User Song) .....	34

## D

Damper Noise .....	46, 53
Damper Resonance .....	46
Delete (User Song) .....	35
Demo Song .....	24, 72
Duplex Scale .....	53
Duplex Scale Resonance .....	46

## E

Ending .....	50
External Song .....	24

## F

Format (USB flash drive) .....	56
Function .....	44
Function List .....	45

## G

Glossary .....	53
Grand Expression Modeling .....	46, 53

## H

Half Pedal Point .....	47
Headphone hanger .....	19
Headphones .....	18

## I

IAC .....	49
Infrastructure mode .....	62
Initializing .....	54
Intro .....	50

## L

Language .....	37
Layer mode .....	21
Local Control .....	51

## M

Master Tune .....	47
Message .....	65
Metronome .....	38, 50
MIDI recording .....	29
MIDI Reference .....	11
MIDI Song .....	24
MIDI terminals .....	64
MIDI transmit channel .....	51

## P

Pairing .....	52, 59
Pan .....	46
Part .....	28, 31
Playback (Rhythm) .....	41
Playback (Song) .....	24, 27
Power .....	14
Preset Song .....	24, 73

## Q

Quiet mode .....	18
------------------	----

## R

Recording .....	29
Reverb .....	45
Rhythm .....	41, 50
Rhythm List .....	42

## S

Smart device .....	61
Smart Pianist .....	61
Smart Pianist User Guide .....	11
Song .....	24
Song List .....	72
Specifications .....	75
Stereophonic Optimizer .....	19, 49
String Resonance .....	46
Synchro Start .....	51

## T

Temperament .....	48
Tempo .....	27, 39
Time signature .....	39
Touch Sensitivity .....	47
TransAcoustic mode .....	20
TransAcoustic setting .....	49
Transpose (keyboard) .....	47
Transpose (Song) .....	50
Troubleshooting .....	67
Tuning .....	47

## U

USB Audio Interface .....	63
USB device .....	55
USB flash drive .....	55
[USB TO DEVICE] terminal .....	55
User Song .....	24, 34
UTILITY .....	38

## V

Version .....	52
Voice .....	22
Voice Demo Song .....	24, 72
Voice List .....	23, 69
Volume (Audio Song) .....	50
Volume (Metronome/Rhythm) .....	40, 43, 50
Volume (overall) .....	18, 20
Volume balance .....	50
VRM .....	46, 53

## W

Wi-Fi .....	62
Wireless LAN .....	62
WPS .....	62

## Modified BSD license

COPYRIGHT © 2016 STMicroelectronics

Redistribution and use in source and binary forms, with or without modification, are permitted provided that the following conditions are met:

1. Redistributions of source code must retain the above copyright notice, this list of conditions and the following disclaimer.
2. Redistributions in binary form must reproduce the above copyright notice, this list of conditions and the following disclaimer in the documentation and/or other materials provided with the distribution.
3. Neither the name of STMicroelectronics nor the names of its contributors may be used to endorse or promote products derived from this software without specific prior written permission.

THIS SOFTWARE IS PROVIDED BY THE COPYRIGHT HOLDERS AND CONTRIBUTORS "AS IS" AND ANY EXPRESS OR IMPLIED WARRANTIES, INCLUDING, BUT NOT LIMITED TO, THE IMPLIED WARRANTIES OF MERCHANTABILITY AND FITNESS FOR A PARTICULAR PURPOSE ARE DISCLAIMED. IN NO EVENT SHALL THE COPYRIGHT HOLDER OR CONTRIBUTORS BE LIABLE FOR ANY DIRECT, INDIRECT, INCIDENTAL, SPECIAL, EXEMPLARY, OR CONSEQUENTIAL DAMAGES (INCLUDING, BUT NOT LIMITED TO, PROCUREMENT OF SUBSTITUTE GOODS OR SERVICES; LOSS OF USE, DATA, OR PROFITS; OR BUSINESS INTERRUPTION) HOWEVER CAUSED AND ON ANY THEORY OF LIABILITY, WHETHER IN CONTRACT, STRICT LIABILITY, OR TORT (INCLUDING NEGLIGENCE OR OTHERWISE) ARISING IN ANY WAY OUT OF THE USE OF THIS SOFTWARE, EVEN IF ADVISED OF THE POSSIBILITY OF SUCH DAMAGE.

## Apache License 2.0

Copyright (c) 2009-2018 Arm Limited. All rights reserved.

SPDX-License-Identifier: Apache-2.0

Licensed under the Apache License, Version 2.0 (the License); you may not use this file except in compliance with the License.

You may obtain a copy of the License at  
[www.apache.org/licenses/LICENSE-2.0](http://www.apache.org/licenses/LICENSE-2.0)

Unless required by applicable law or agreed to in writing, software distributed under the License is distributed on an AS IS BASIS, WITHOUT WARRANTIES OR CONDITIONS OF ANY KIND, either express or implied.  
See the License for the specific language governing permissions and limitations under the License.

## For U.S.A.

This transmitter must not be co-located or operated in conjunction with any other antenna or transmitter.

(554-M01 FCC transmitter 01)

This equipment complies with FCC radiation exposure limits set forth for an uncontrolled environment and meets the FCC radio frequency (RF) Exposure Guidelines. This equipment has very low levels of RF energy that is deemed to comply without testing of specific absorption rate (SAR).

(554-M04 FCC portable 01)

## For Canada

This equipment complies with ISED radiation exposure limits set forth for an uncontrolled environment and meets RSS-102 of the ISED radio frequency (RF) Exposure rules as this equipment has very low levels of RF energy.

Cet équipement est conforme aux limites d'exposition aux rayonnements énoncées pour un environnement non contrôlé et respecte les règles d'exposition aux fréquences radioélectriques (RF) CNR-102 de l'ISDE puisque cet appareil a un niveau très bas d'énergie RF.

(0555-M05\_ised\_portable\_01)

This device contains licence-exempt transmitter(s)/receiver(s) that comply with Innovation, Science and Economic Development Canada's licence-exempt RSS(s). Operation is subject to the following two conditions:

1. This device may not cause interference.
2. This device must accept any interference, including interference that may cause undesired operation of the device.

L'émetteur/récepteur exempt de licence contenu dans le présent appareil est conforme aux CNR d'Innovation, Sciences et Développement économique Canada applicables aux appareils radio exempts de licence. L'exploitation est autorisée aux deux conditions suivantes :

1. L'appareil ne doit pas produire de brouillage;
2. L'appareil doit accepter tout brouillage radioélectrique subi, même si le brouillage est susceptible d'en compromettre le fonctionnement.

(555-M13 ISED RSS 01)

## For Mexico

La operación de este equipo está sujeta a las siguientes dos condiciones: (1) es posible que este equipo o dispositivo no cause interferencia perjudicial y (2) este equipo o dispositivo debe aceptar cualquier interferencia, incluyendo la que pueda causar su operación no deseada.

(556-M02 MX operating condition 01)



## For European Union and United Kingdom

<b>EN</b>	<b>SIMPLIFIED EU DECLARATION OF CONFORMITY / SIMPLIFIED UK DECLARATION OF CONFORMITY</b>
<p>Hereby, Yamaha Music Europe GmbH declares that the radio equipment type [TA3, SH3, SC3] is in compliance with Directive 2014/53/EU and the radio equipment regulations of UK. The full texts of the EU declaration of conformity and the UK declaration of conformity are available at the following internet address: <a href="https://europe.yamaha.com/en/support/compliance/doc.html">https://europe.yamaha.com/en/support/compliance/doc.html</a></p>	
<b>FR</b>	<b>DECLARATION UE DE CONFORMITE SIMPLIFIEE</b>
<p>Le soussigné, Yamaha Music Europe GmbH, déclare que l'équipement radioélectrique du type [TA3, SH3, SC3] est conforme à la directive 2014/53/UE. Le texte complet de la déclaration UE de conformité est disponible à l'adresse internet suivante : <a href="https://europe.yamaha.com/en/support/compliance/doc.html">https://europe.yamaha.com/en/support/compliance/doc.html</a></p>	
<b>DE</b>	<b>VEREINFACHTE EU-KONFORMITÄTSEKTLÄRUNG</b>
<p>Hiermit erklärt Yamaha Music Europe GmbH, dass der Funkanlagentyp [TA3, SH3, SC3] der Richtlinie 2014/53/EU entspricht. Der vollständige Text der EU-Konformitätserklärung ist unter der folgenden Internetadresse verfügbar: <a href="https://europe.yamaha.com/en/support/compliance/doc.html">https://europe.yamaha.com/en/support/compliance/doc.html</a></p>	
<b>SV</b>	<b>FÖRENKLAD EU-FÖRSÄKRAN OM ÖVERENSSTÄMMELSE</b>
<p>Härmed försäkrar Yamaha Music Europe GmbH att denna typ av radioutrustning [TA3, SH3, SC3] överensstämmer med direktiv 2014/53/EU. Den fullständiga texten till EU-försäkran om överensstämmelse finns på följande webbadress: <a href="https://europe.yamaha.com/en/support/compliance/doc.html">https://europe.yamaha.com/en/support/compliance/doc.html</a></p>	
<b>IT</b>	<b>DICHIARAZIONE DI CONFORMITÀ UE SEMPLIFICATA</b>
<p>Il fabbricante, Yamaha Music Europe GmbH, dichiara che il tipo di apparecchiatura radio [TA3, SH3, SC3] è conforme alla direttiva 2014/53/UE. Il testo completo della dichiarazione di conformità UE è disponibile al seguente indirizzo Internet: <a href="https://europe.yamaha.com/en/support/compliance/doc.html">https://europe.yamaha.com/en/support/compliance/doc.html</a></p>	
<b>ES</b>	<b>DECLARACIÓN UE DE CONFORMIDAD SIMPLIFICADA</b>
<p>Por la presente, Yamaha Music Europe GmbH declara que el tipo de equipo radioeléctrico [TA3, SH3, SC3] es conforme con la Directiva 2014/53/UE. El texto completo de la declaración UE de conformidad está disponible en la dirección Internet siguiente: <a href="https://europe.yamaha.com/en/support/compliance/doc.html">https://europe.yamaha.com/en/support/compliance/doc.html</a></p>	
<b>PT</b>	<b>DECLARAÇÃO UE DE CONFORMIDADE SIMPLIFICADA</b>
<p>O(a) abaixo assinado(a) Yamaha Music Europe GmbH declara que o presente tipo de equipamento de rádio [TA3, SH3, SC3] está em conformidade com a Diretiva 2014/53/UE. O texto integral da declaração de conformidade está disponível no seguinte endereço de Internet: <a href="https://europe.yamaha.com/en/support/compliance/doc.html">https://europe.yamaha.com/en/support/compliance/doc.html</a></p>	
<b>NL</b>	<b>VEREENVOUDIGDE EU-CONFORMITEITSVERKLARING</b>
<p>Hierbij verklaar ik, Yamaha Music Europe GmbH, dat het type radioapparatuur [TA3, SH3, SC3] conform is met Richtlijn 2014/53/EU. De volledige tekst van de EU-conformiteitsverklaring kan worden geraadpleegd op het volgende internetadres: <a href="https://europe.yamaha.com/en/support/compliance/doc.html">https://europe.yamaha.com/en/support/compliance/doc.html</a></p>	
<b>BG</b>	<b>ОПРОСТЕНА ЕС ДЕКЛАРАЦИЯ ЗА СЪОТВЕТСТВИЕ</b>
<p>С настоящото Yamaha Music Europe GmbH декларира, че този тип радиосъоръжение [TA3, SH3, SC3] е в съответствие с Директива 2014/53/ЕС. Цялостният текст на ЕС декларацията за съответствие може да се намери на следния интернет адрес: <a href="https://europe.yamaha.com/en/support/compliance/doc.html">https://europe.yamaha.com/en/support/compliance/doc.html</a></p>	
<b>CS</b>	<b>ZJEDNODUŠENÉ EU PROHLÁŠENÍ O SHODĚ</b>
<p>Tímto Yamaha Music Europe GmbH prohlašuje, že typ rádiového zařízení [TA3, SH3, SC3] je v souladu se směrnicí 2014/53/EU. Úplné znění EU prohlášení o shodě je k dispozici na této internetové adrese: <a href="https://europe.yamaha.com/en/support/compliance/doc.html">https://europe.yamaha.com/en/support/compliance/doc.html</a></p>	
<b>DA</b>	<b>FORENKLET EU-OVERENSSTEMMELSESEKTLÆRING</b>
<p>Hermed erklærer Yamaha Music Europe GmbH, at radioudstyrstypen [TA3, SH3, SC3] er i overensstemmelse med direktiv 2014/53/EU. EU-overensstemmelseserklæringens fulde tekst kan findes på følgende internetadresse: <a href="https://europe.yamaha.com/en/support/compliance/doc.html">https://europe.yamaha.com/en/support/compliance/doc.html</a></p>	
<b>ET</b>	<b>LIHTSUSTATUD ELI VASTAVUSDEKLARATSIOON</b>
<p>Käesolevaga deklareerib Yamaha Music Europe GmbH, et käesolev raadioseadme tüüp [TA3, SH3, SC3] vastab direktiivi 2014/53/EL nõuetele. ELi vastavusdeklaratsiooni täielik tekst on kättesaadav järgmisel internetiaadressil: <a href="https://europe.yamaha.com/en/support/compliance/doc.html">https://europe.yamaha.com/en/support/compliance/doc.html</a></p>	

<b>EL</b>	<b>ΑΠΛΟΥΣΤΕΥΜΕΝΗ ΔΗΛΩΣΗ ΣΥΜΜΟΡΦΩΣΗΣ ΕΕ</b>
	<p>Με την παρούσα ο/η Yamaha Music Europe GmbH, δηλώνει ότι ο ραδιοεξοπλισμός [TA3, SH3, SC3] πληροί την οδηγία 2014/53/ΕΕ. Το πλήρες κείμενο της δήλωσης συμμόρφωσης ΕΕ διατίθεται στην ακόλουθη ιστοσελίδα στο διαδίκτυο:  <a href="https://europe.yamaha.com/en/support/compliance/doc.html">https://europe.yamaha.com/en/support/compliance/doc.html</a></p>
<b>HR</b>	<b>POJEDNOSTAVLJENA EU IZJAVA O SUKLADNOSTI</b>
	<p>Yamaha Music Europe GmbH ovime izjavljuje da je radijska oprema tipa [TA3, SH3, SC3] u skladu s Direktivom 2014/53/EU. Cjeloviti tekst EU izjave o sukladnosti dostupan je na sljedećoj internetskoj adresi:  <a href="https://europe.yamaha.com/en/support/compliance/doc.html">https://europe.yamaha.com/en/support/compliance/doc.html</a></p>
<b>LV</b>	<b>VIENKĀRŠOTA ES ATBILSTĪBAS DEKLARĀCIJA</b>
	<p>Ar šo Yamaha Music Europe GmbH deklarē, ka radioiekārta [TA3, SH3, SC3] atbilst Direktīvai 2014/53/ES. Pilns ES atbilstības deklarācijas teksts ir pieejams šādā interneta vietnē:  <a href="https://europe.yamaha.com/en/support/compliance/doc.html">https://europe.yamaha.com/en/support/compliance/doc.html</a></p>
<b>LT</b>	<b>SUPAPRASTINTA ES ATITIKTIES DEKLARACIJA</b>
	<p>Aš, Yamaha Music Europe GmbH, patvirtinu, kad radijo įrenginių tipas [TA3, SH3, SC3] atitinka Direktyvą 2014/53/ES. Visas ES atitikties deklaracijos tekstas prieinamas šiuo interneto adresu:  <a href="https://europe.yamaha.com/en/support/compliance/doc.html">https://europe.yamaha.com/en/support/compliance/doc.html</a></p>
<b>HU</b>	<b>EGYSZERŰSÍTETT EU-MEGFELELŐSÉGI NYILATKOZAT</b>
	<p>Yamaha Music Europe GmbH igazolja, hogy a [TA3, SH3, SC3] típusú rádióberendezés megfelel a 2014/53/EU irányelvnek. Az EU-megfelelőségi nyilatkozat teljes szövege elérhető a következő internetes címen:  <a href="https://europe.yamaha.com/en/support/compliance/doc.html">https://europe.yamaha.com/en/support/compliance/doc.html</a></p>
<b>PL</b>	<b>UPROSZCZONA DEKLARACJA ZGODNOŚCI UE</b>
	<p>Yamaha Music Europe GmbH niniejszym oświadcza, że typ urządzenia radiowego [TA3, SH3, SC3] jest zgodny z dyrektywą 2014/53/UE. Pełny tekst deklaracji zgodności UE jest dostępny pod następującym adresem internetowym:  <a href="https://europe.yamaha.com/en/support/compliance/doc.html">https://europe.yamaha.com/en/support/compliance/doc.html</a></p>
<b>RO</b>	<b>DECLARAȚIA UE DE CONFORMITATE SIMPLIFICATĂ</b>
	<p>Prin prezenta, Yamaha Music Europe GmbH declară că tipul de echipamente radio [TA3, SH3, SC3] este în conformitate cu Directiva 2014/53/UE. Textul integral al declarației UE de conformitate este disponibil la următoarea adresă internet:  <a href="https://europe.yamaha.com/en/support/compliance/doc.html">https://europe.yamaha.com/en/support/compliance/doc.html</a></p>
<b>SK</b>	<b>ZJEDNODUŠENÉ EÚ VYHLÁSENIE O ZHODE</b>
	<p>Yamaha Music Europe GmbH týmto vyhlasuje, že rádiové zariadenie typu [TA3, SH3, SC3] je v súlade so smernicou 2014/53/EÚ. Úplné EÚ vyhlásenie o zhode je k dispozícii na tejto internetovej adrese:  <a href="https://europe.yamaha.com/en/support/compliance/doc.html">https://europe.yamaha.com/en/support/compliance/doc.html</a></p>
<b>SL</b>	<b>POENOSTAVLJENA IZJAVA EU O SKLADNOSTI</b>
	<p>Yamaha Music Europe GmbH potrjuje, da je tip radijske opreme [TA3, SH3, SC3] skladen z Direktivo 2014/53/EU. Celotno besedilo izjave EU o skladnosti je na voljo na naslednjem spletnem naslovu:  <a href="https://europe.yamaha.com/en/support/compliance/doc.html">https://europe.yamaha.com/en/support/compliance/doc.html</a></p>
<b>FI</b>	<b>YKSINKERTAISTETTU EU-VAATIMUSTENMUKAISUUSVAKUUTUS</b>
	<p>Yamaha Music Europe GmbH vakuuttaa, että radiolaitetyypin [TA3, SH3, SC3] on direktiivin 2014/53/EU mukainen. EU-vaatimustenmukaisuusvakuutuksen täysimittainen teksti on saatavilla seuraavassa internetosoitteessa:  <a href="https://europe.yamaha.com/en/support/compliance/doc.html">https://europe.yamaha.com/en/support/compliance/doc.html</a></p>
<b>TR</b>	<b>BASİTLEŞTİRİLMİŞ AVRUPA BİRLİĞİ UYGUNLUK BİLDİRİMİ</b>
	<p>İşbu belge ile, Yamaha Music Europe GmbH, radyo cihaz tipinin [TA3, SH3, SC3], Direktif 2014/53/ AB'ye uygunluğunu beyan eder. AB uyumu beyanının tam metni aşağıdaki internet adresinden edinilebilir:  <a href="https://europe.yamaha.com/en/support/compliance/doc.html">https://europe.yamaha.com/en/support/compliance/doc.html</a></p>

(559-M01 RED DoC URL 02)

### Information for users on collection and disposal of old equipment:



This symbol on the products, packaging, and/or accompanying documents means that used electrical and electronic products should not be mixed with general household waste.

For proper treatment, recovery and recycling of old products, please take them to applicable collection points, in accordance with your national legislation.

By disposing of these products correctly, you will help to save valuable resources and prevent any potential negative effects on human health and the environment which could otherwise arise from inappropriate waste handling.

For more information about collection and recycling of old products, please contact your local municipality, your waste disposal service or the point of sale where you purchased the items.

#### For business users in the European Union:

If you wish to discard electrical and electronic equipment, please contact your dealer or supplier for further information.

#### Information on Disposal in other Countries outside the European Union:

This symbol is only valid in the European Union. If you wish to discard these items, please contact your local authorities or dealer and ask for the correct method of disposal.

(58-M02 WEEE en 01)

### Información para usuarios sobre la recogida y eliminación de los equipos antiguos



Este símbolo en los productos, embalajes y documentos anexos significa que los productos eléctricos y electrónicos no deben mezclarse con los desperdicios domésticos normales.

Para el tratamiento, recuperación y reciclaje apropiados de los productos antiguos, llévelos a puntos de reciclaje correspondientes, de acuerdo con la legislación nacional.

Al deshacerse de estos productos de forma correcta, ayudará a ahorrar recursos valiosos y a impedir los posibles efectos desfavorables en la salud humana y en el entorno que de otro modo se producirían si se trataran los desperdicios de modo inapropiado.

Para obtener más información acerca de la recogida y el reciclaje de los productos antiguos, póngase en contacto con las autoridades locales, con el servicio de eliminación de basuras o con el punto de venta donde adquirió los artículos.

#### Para los usuarios empresariales de la Unión Europea:

Si desea desechar equipos eléctricos y electrónicos, póngase en contacto con su vendedor o proveedor para obtener más información.

#### Información sobre la eliminación en otros países fuera de la Unión Europea:

Este símbolo solo es válido en la Unión Europea. Si desea desechar estos artículos, póngase en contacto con las autoridades locales o con el vendedor y pregúnteles el método correcto.

(58-M02 WEEE es 01)

### Informations concernant la collecte et le traitement des déchets d'équipements électriques et électroniques



Le symbole sur les produits, l'emballage et/ou les documents joints signifie que les produits électriques ou électroniques usagés ne doivent pas être mélangés avec les déchets domestiques habituels.

Pour un traitement, une récupération et un recyclage appropriés des déchets d'équipements électriques et électroniques, veuillez les déposer aux points de collecte prévus à cet effet, conformément à la réglementation nationale.

En vous débarrassant correctement des déchets d'équipements électriques et électroniques, vous contribuerez à la sauvegarde de précieuses ressources et à la prévention de potentiels effets négatifs sur la santé humaine qui pourraient advenir lors d'un traitement inapproprié des déchets.

Pour plus d'informations à propos de la collecte et du recyclage des déchets d'équipements électriques et électroniques, veuillez contacter votre municipalité, votre service de traitement des déchets ou le point de vente où vous avez acheté les produits.

#### Pour les professionnels dans l'Union européenne :

Si vous souhaitez vous débarrasser des déchets d'équipements électriques et électroniques, veuillez contacter votre vendeur ou fournisseur pour plus d'informations.

#### Informations sur la mise au rebut dans d'autres pays en dehors de l'Union européenne :

Ce symbole est seulement valable dans l'Union européenne. Si vous souhaitez vous débarrasser de déchets d'équipements électriques et électroniques, veuillez contacter les autorités locales ou votre fournisseur et demander la méthode de traitement appropriée.

(58-M02 WEEE fr 01)

## Verbraucherinformation zur Sammlung und Entsorgung alter Elektrogeräte



Befindet sich dieses Symbol auf den Produkten, der Verpackung und/oder beiliegenden Unterlagen, so sollten benutzte elektrische Geräte nicht mit dem normalen Haushaltsabfall entsorgt werden. In Übereinstimmung mit Ihren nationalen Bestimmungen bringen Sie alte Geräte bitte zur fachgerechten Entsorgung, Wiederaufbereitung und Wiederverwendung zu den entsprechenden Sammelstellen.

Durch die fachgerechte Entsorgung der Elektrogeräte helfen Sie, wertvolle Ressourcen zu schützen, und verhindern mögliche negative Auswirkungen auf die menschliche Gesundheit und die Umwelt, die andernfalls durch unsachgerechte Müllentsorgung auftreten könnten.

Für weitere Informationen zum Sammeln und Wiederaufbereiten alter Elektrogeräte kontaktieren Sie bitte Ihre örtliche Stadt- oder Gemeindeverwaltung, Ihren Abfallentsorgungsdienst oder die Verkaufsstelle der Artikel.

### Information für geschäftliche Anwender in der Europäischen Union:

Wenn Sie Elektrogeräte ausrangieren möchten, kontaktieren Sie bitte Ihren Händler oder Zulieferer für weitere Informationen.

### Entsorgungsinformation für Länder außerhalb der Europäischen Union:

Dieses Symbol gilt nur innerhalb der Europäischen Union. Wenn Sie solche Artikel ausrangieren möchten, kontaktieren Sie bitte Ihre örtlichen Behörden oder Ihren Händler und fragen Sie nach der sachgerechten Entsorgungsmethode.

(58-M02 WEEE de 01)

## Informazioni per gli utenti sulla raccolta e lo smaltimento di vecchia attrezzatura



Questi simboli sui prodotti, sull'imballaggio e/o sui documenti che li accompagnano, indicano che i prodotti elettrici ed elettronici non devono essere mischiati con i rifiuti generici.

Per il trattamento, il recupero e il riciclaggio appropriato di vecchi prodotti, si prega di portarli ai punti di raccolta designati, in accordo con la legislazione locale.

Smaltendo correttamente questi prodotti si potranno recuperare risorse preziose, oltre a prevenire potenziali effetti negativi sulla salute e l'ambiente che potrebbero sorgere a causa del trattamento improprio dei rifiuti.

Per ulteriori informazioni sulla raccolta e il riciclaggio di vecchi prodotti, si prega di contattare l'amministrazione comunale locale, il servizio di smaltimento dei rifiuti o il punto vendita dove sono stati acquistati gli articoli.

### Per utenti imprenditori dell'Unione europea:

Se si desidera scartare attrezzatura elettrica ed elettronica, si prega di contattare il proprio rivenditore o il proprio fornitore per ulteriori informazioni.

### Informazioni sullo smaltimento negli altri Paesi al di fuori dell'Unione europea:

Questi simboli sono validi solamente nell'Unione Europea; se si desidera scartare questi articoli, si prega di contattare le autorità locali o il rivenditore e richiedere informazioni sulla corretta modalità di smaltimento.

(58-M02 WEEE it 01)



YAMAHA CORPORATION

10-1, Naka-ku, Hamamatsu, 430-8650 JAPAN

© 2022 Yamaha Corporation

Published 09/2022

MWTOYI-A0



YN413A0